

Mounted Shooters of America



Range Master Pattern Book

Legend



Rundown Barrel



Random Barrel



Dark Targets



Light Targets

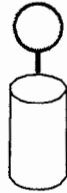

Target on top of barrel. May be shot from either direction.

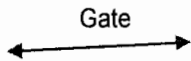

Gate



Round barrel in either direction



Round the barrel in the direction of the arrow



Full Barrel Turn - Is a 360 turn around the barrel, crossing your path. The barrel turn may be made from either direction

TTR

Two Balloon Rule If a contestant hits two balloons with one shot they may use the remaining round to pick up a target.

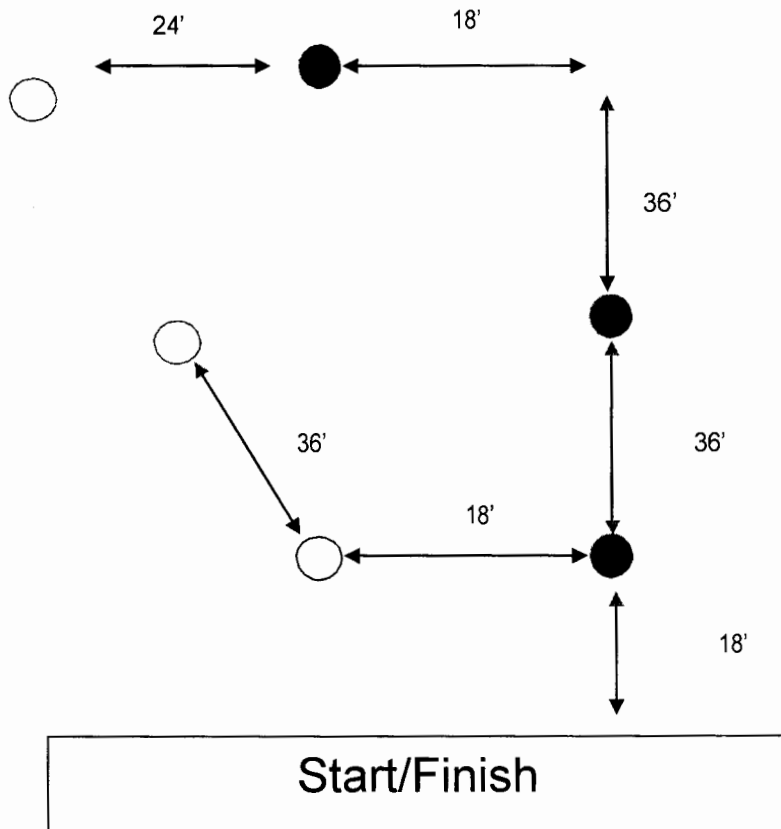
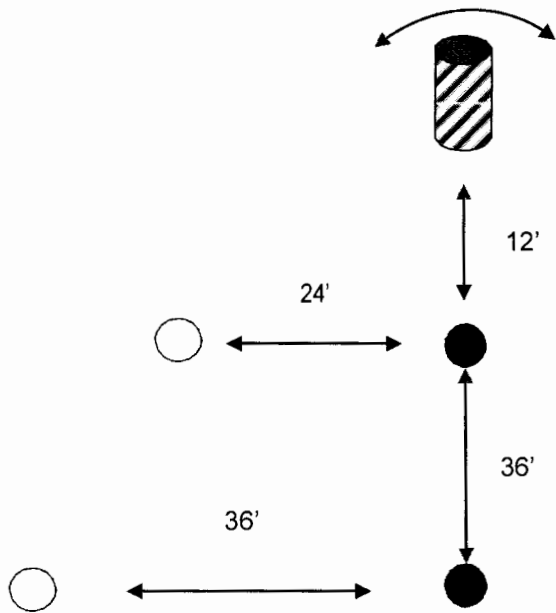

Course Rules

- 1) Shoot all light targets first
- 2) Round rundown barrel
- 3) Shoot all dark targets

Pattern 2

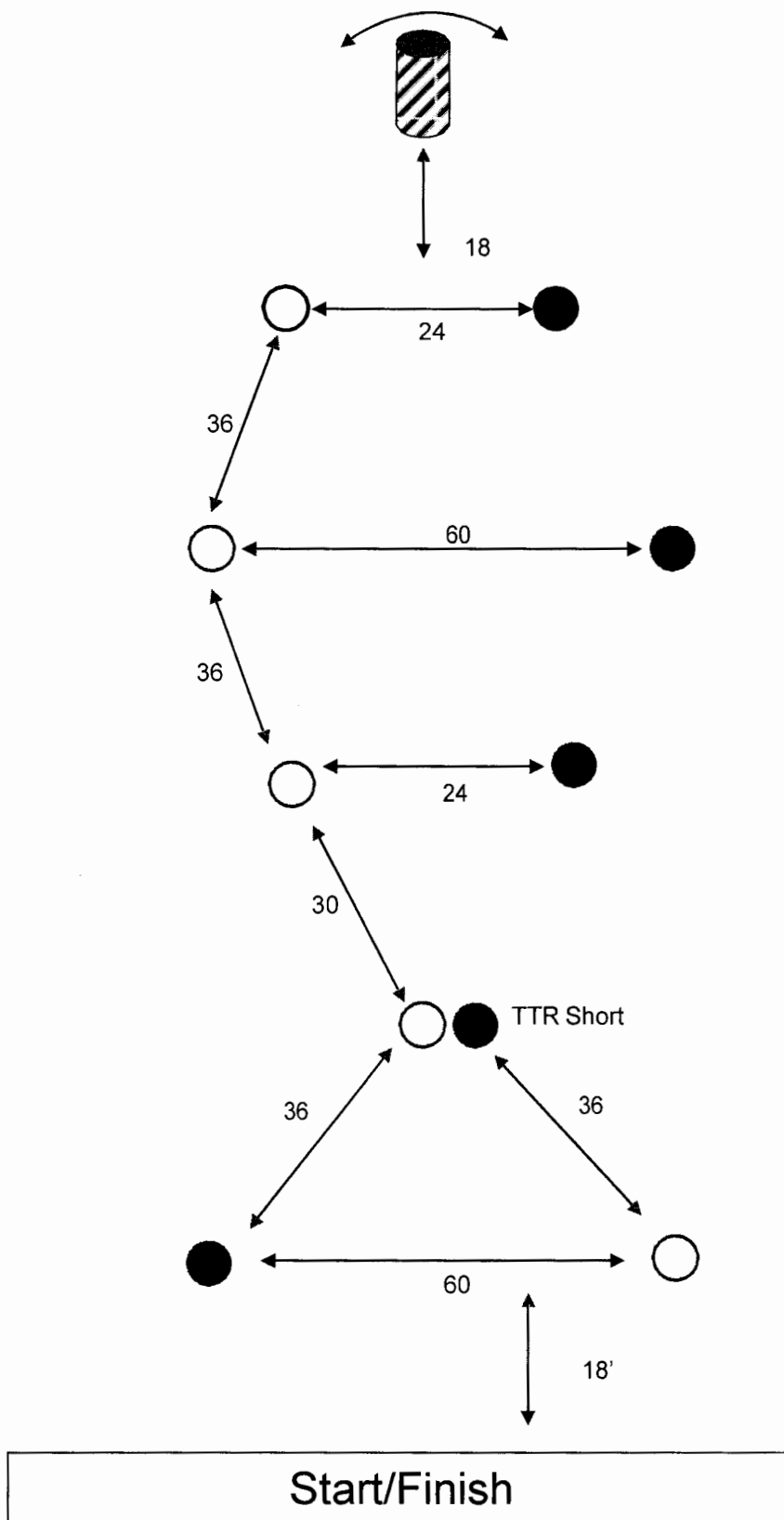

Course Rules

- 1) Shoot all targets of the same color
- 2) Round rundown barrel
- 3) Shoot all targets of the remaining color

Pattern 3

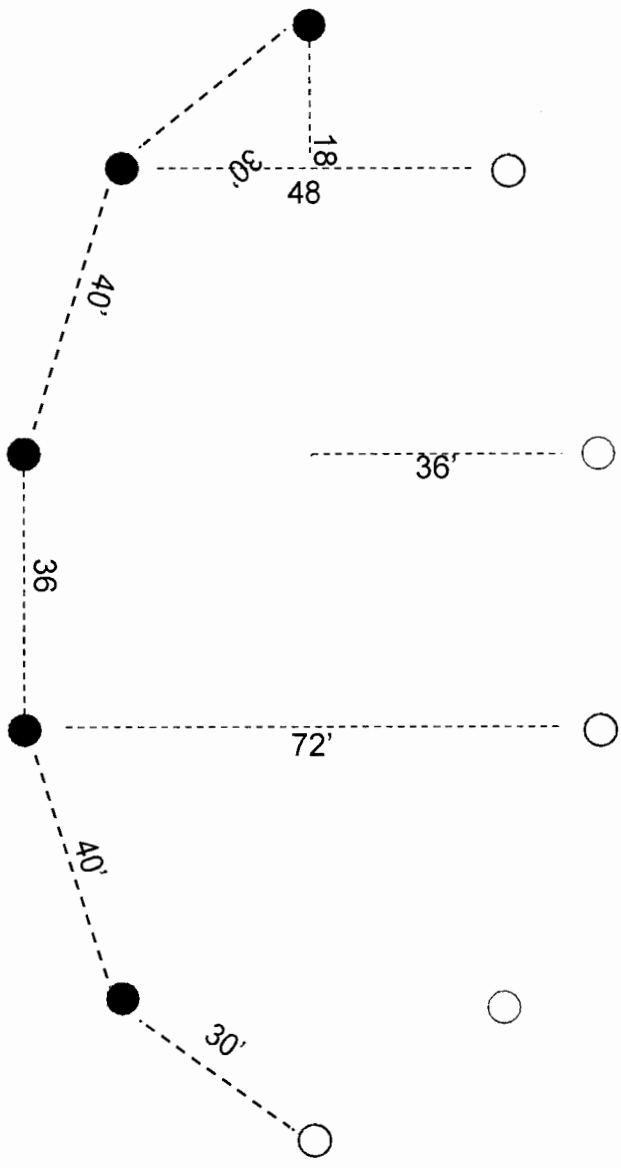

START/FINISH

Engage all five targets of one color, then engage all five targets of the other color
 PROCEDURALS
 failure to engage all the targets of one color before engaging targets of the second color

Pattern 4

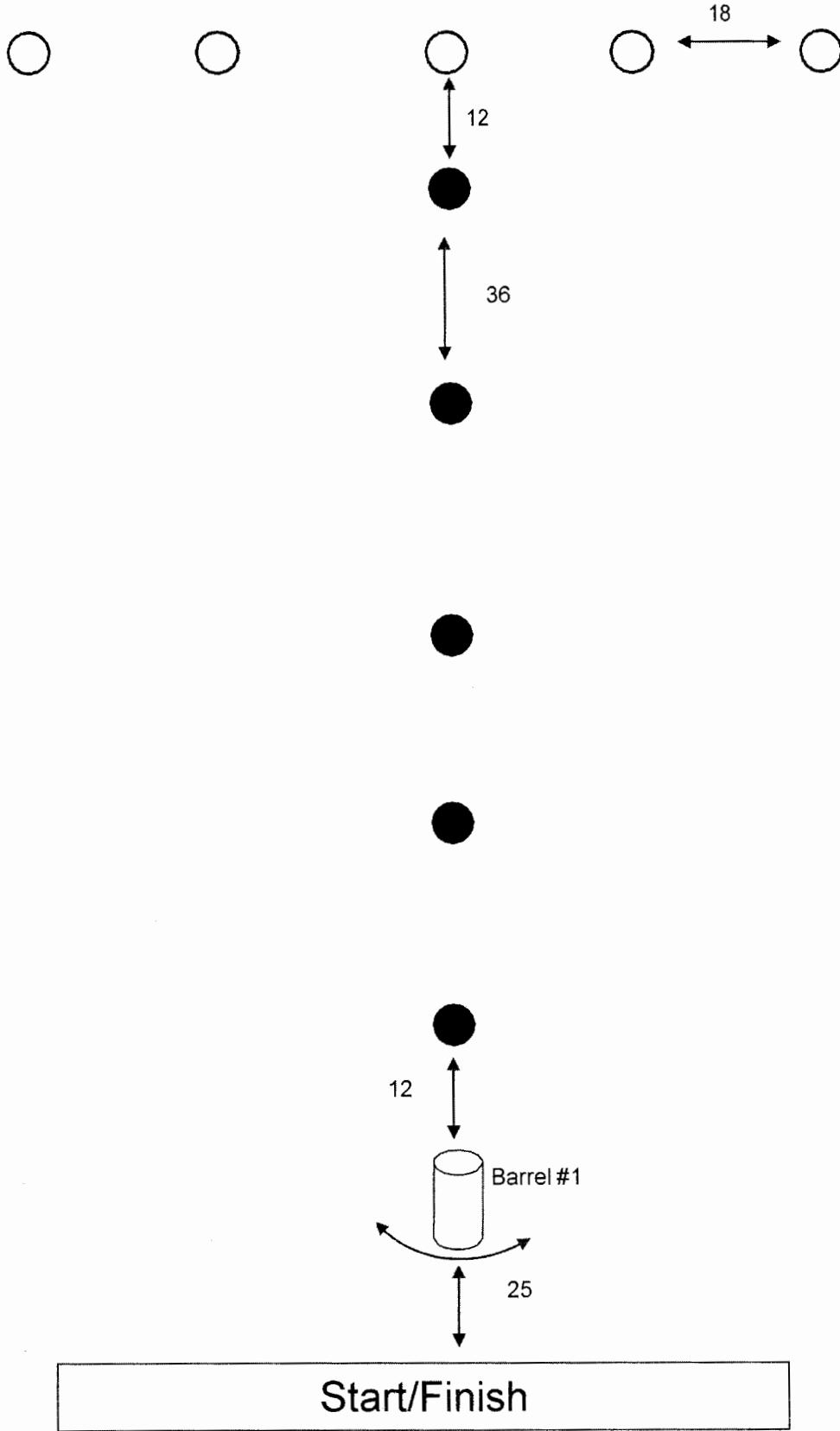

Course Rules

- 1) Shoot all light targets
- 2) Round barrel #1
- 3) Shoot all dark targets

Pattern 5

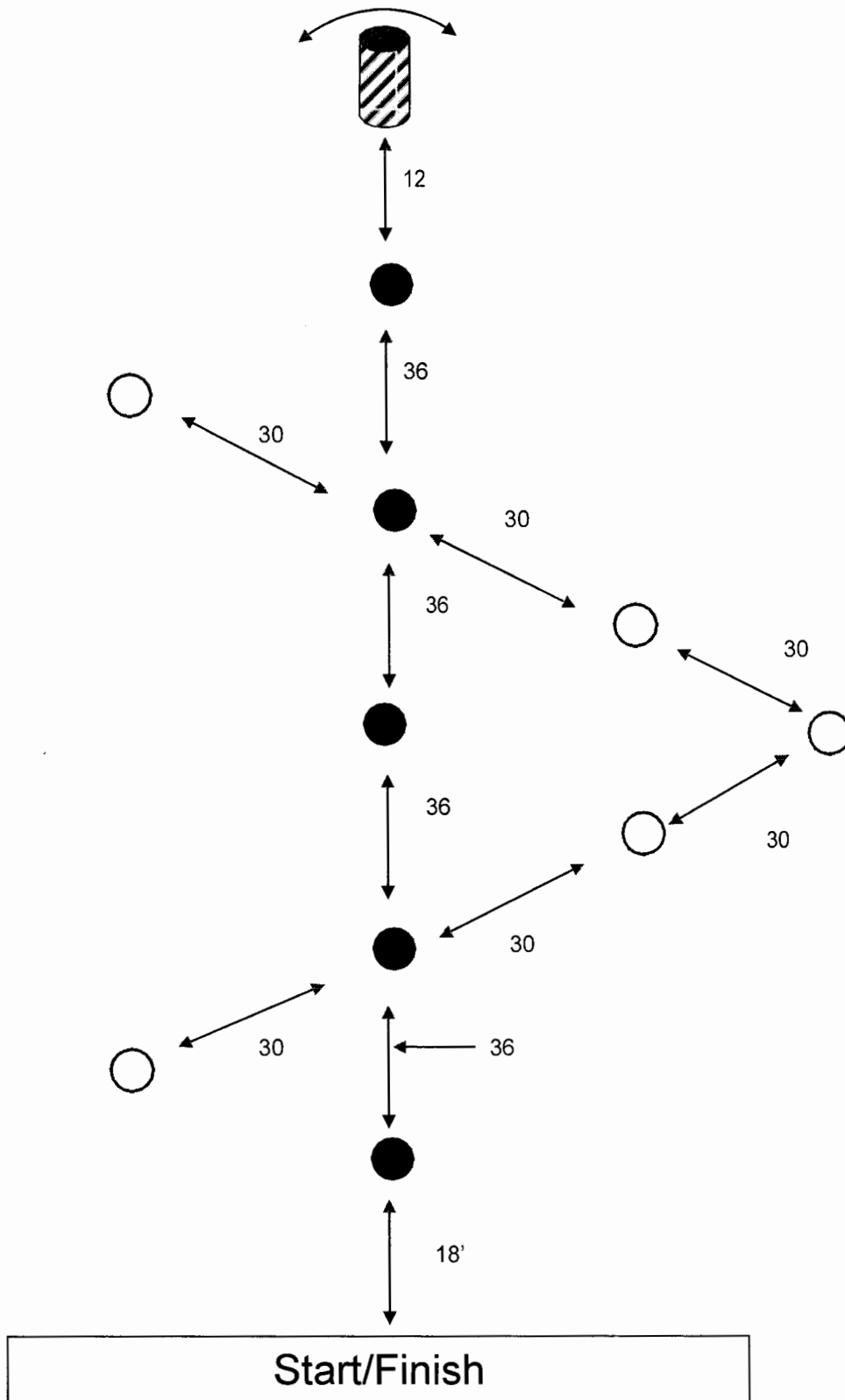

Course Rules

- 1) Shoot all light targets
- 2) Round rundown barrel
- 3) Shoot all dark targets

Pattern 6

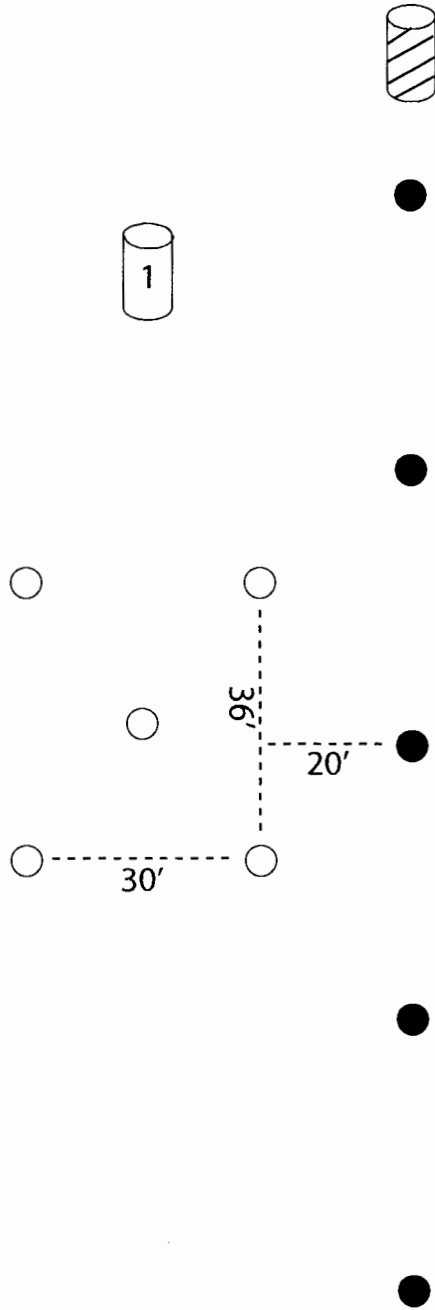

START/FINISH

Round #1 random barrel first

Engage light targets

Round rundown barrel

Engage dark targets

PROCEDURALS

failure to round #1 random barrel first

failure to engage all light targets before rounding the rundown barrel

failure to round rundown barrel

Pattern 7

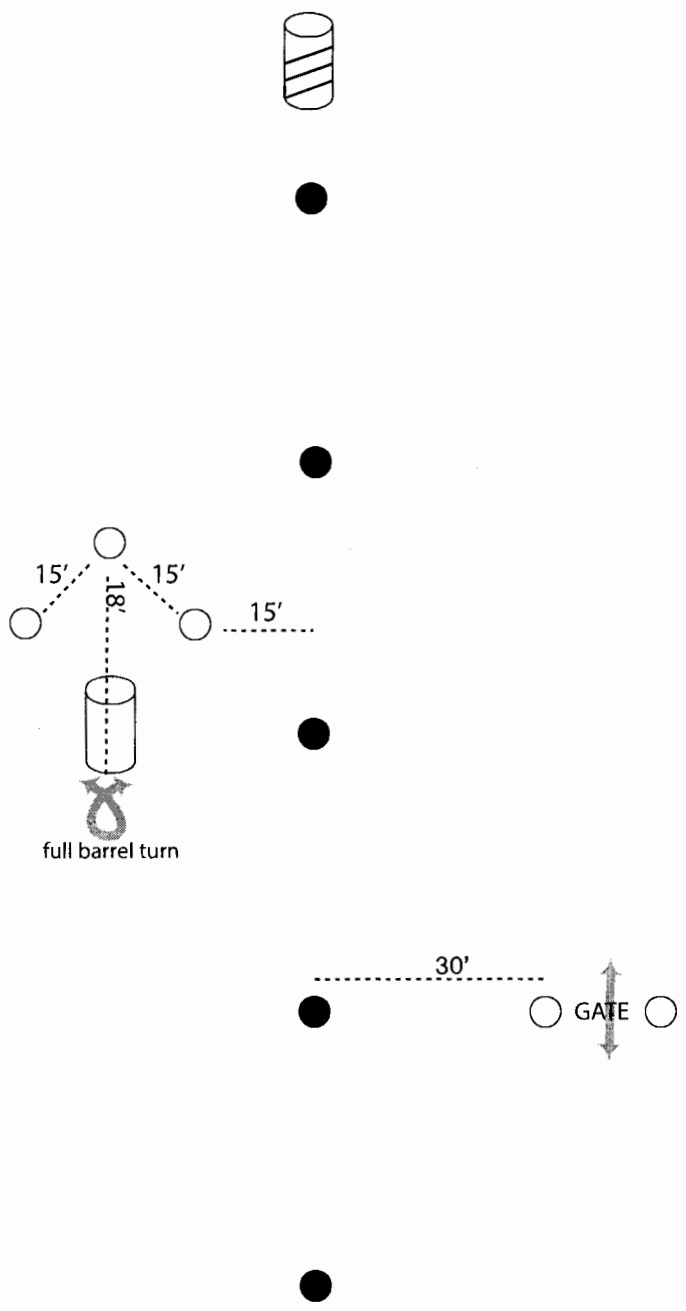

START/FINISH

- Engage all light targets first
- Full Barrel Turn around random barrel
- Round rundown barrel
- Engage dark targets
- PROCEDURALS
- failure to pass through gate
- failure to engage all light targets before turning random barrel
- failure to execute full barrel turn at random barrel
- failure to round rundown barrel

Pattern 8

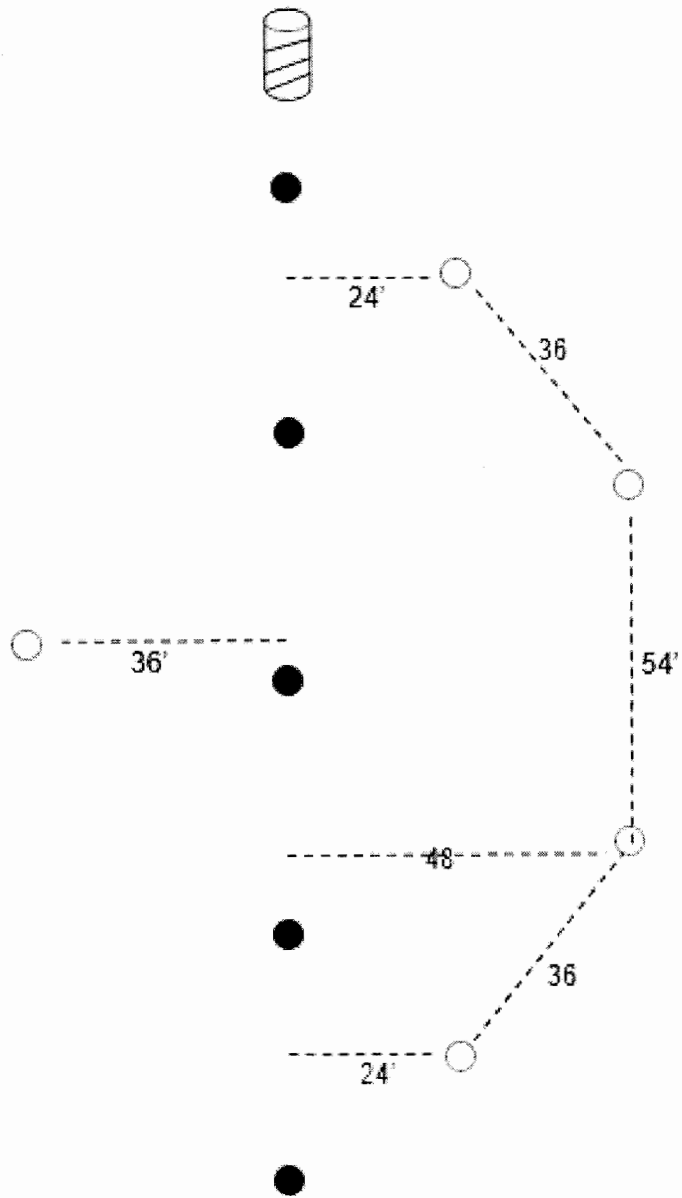

START/FINISH

Engage all light targets before rounding the rundown barrel
 Round rundown barrel
 Engage all dark targets

PROCEDURALS:

failure to engage all light targets before rounding rundown barrel
 failure to round rundown barrel

Pattern 9

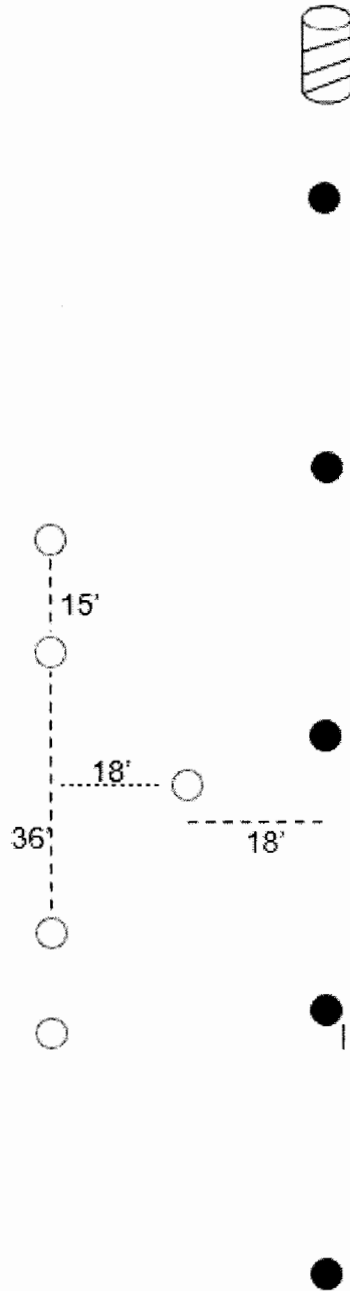

START/FINISH

Engage all light targets before rounding the rundown barrel

Round rundown barrel

Engage all dark targets

PROCEDURALS:

failure to engage all light targets before rounding rundown barrel

failure to round rundown barrel

Pattern 10

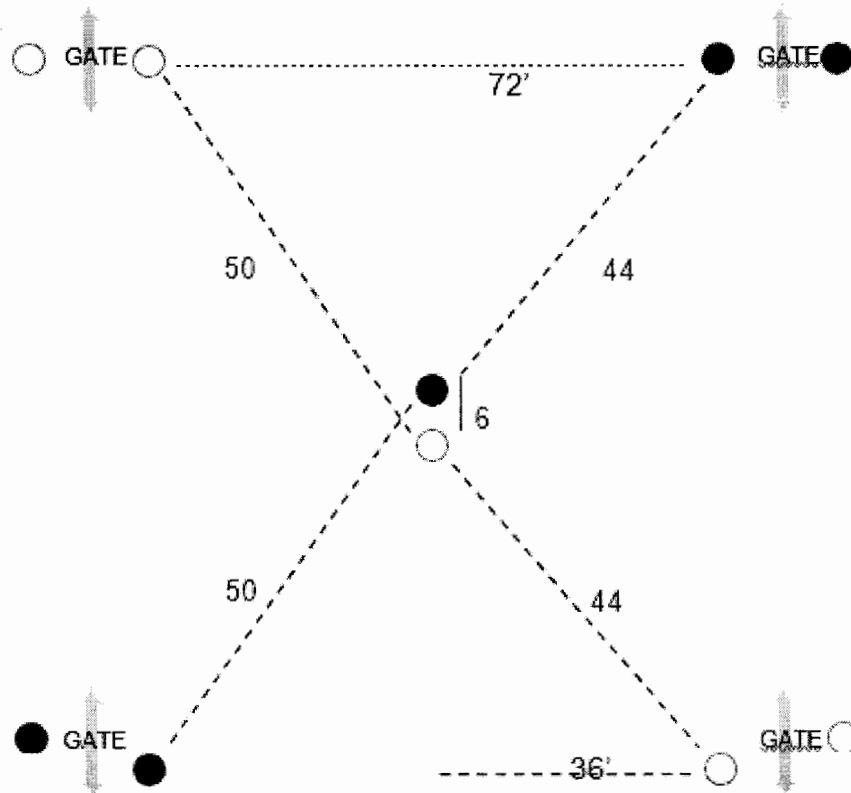
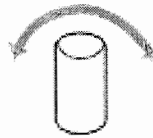

START/FINISH

Engage all targets of one color before rounding the random barrel

Round random barrel

Engage all targets of the second color

PROCEDURALS:

failure to engage all targets of one color before rounding random barrel

failure to round random barrel

failure to pass through gates

Pattern 11

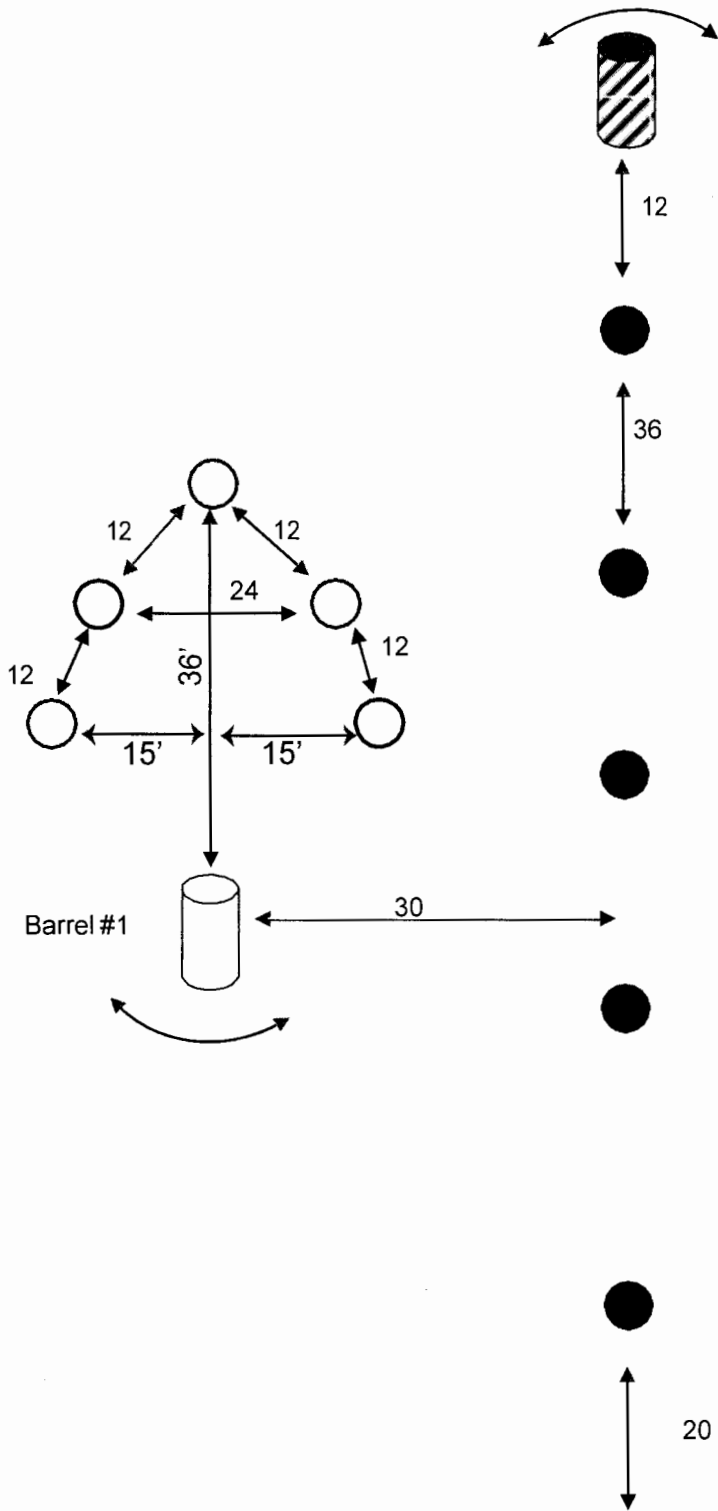

Course Rules

- 1) Shoot all light targets
- 2) Round barrel #1
- 3) Proceed to and round rundown barrel
- 4) Shoot all dark targets

Pattern 13

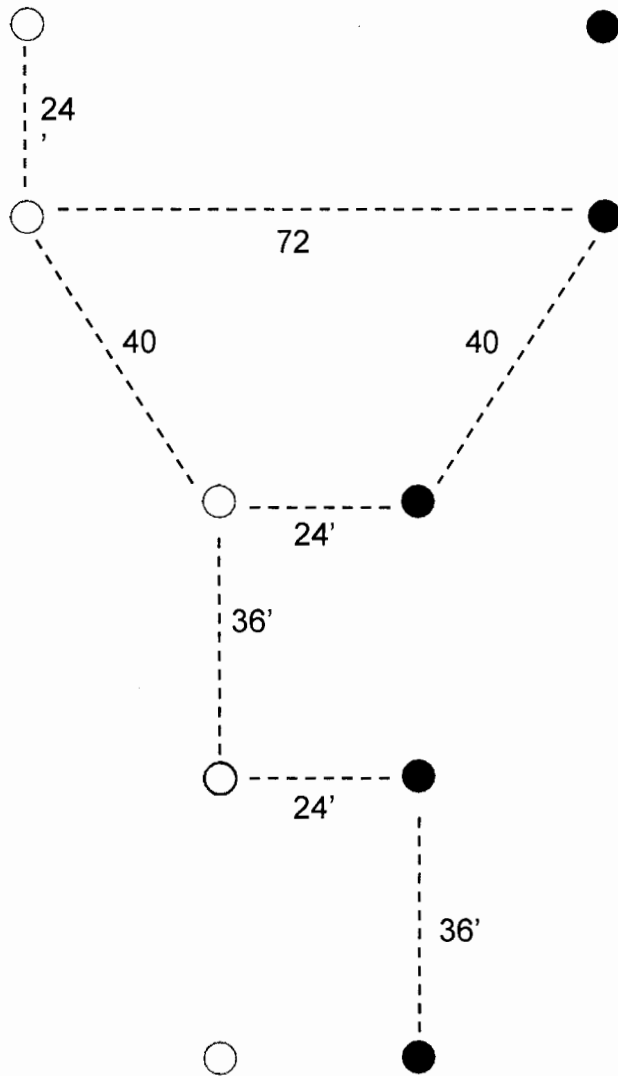

START/FINISH

Engage all targets of one color then round random barrel

Engage all targets of the second color

PROCEDURALS:

failure to engage all targets of one color before rounding the random barrel

failure to round the random barrel

Pattern 14

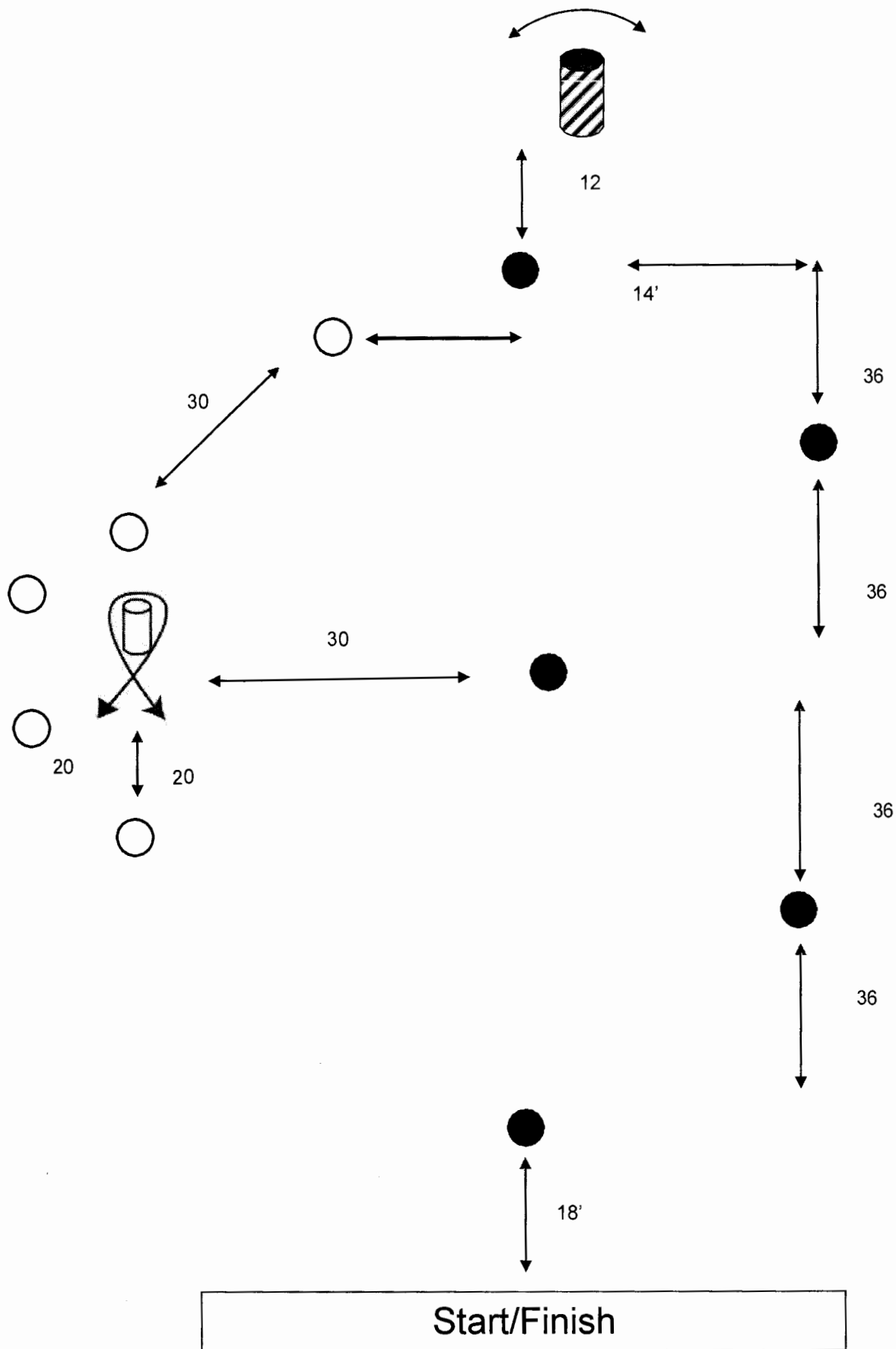

CourseRules

- 1) Shoot all light targets first (Note: you must complete full barrel turn around the random barrel)
- 2) Complete entire random course before rounding the rundown barrel
- 3) Shoot all dark targets

Pattern 15

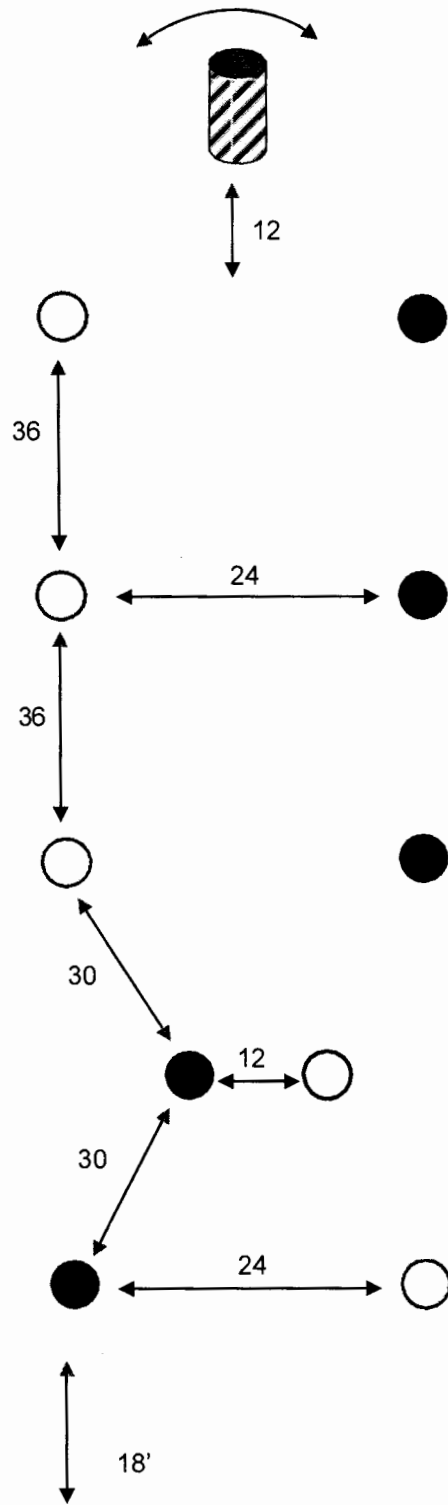

Start/Finish

Course Rules

- 1) Shoot all targets of the same color
- 2) Round rundown barrel
- 3) Shoot all targets of the remaining color

Pattern 16

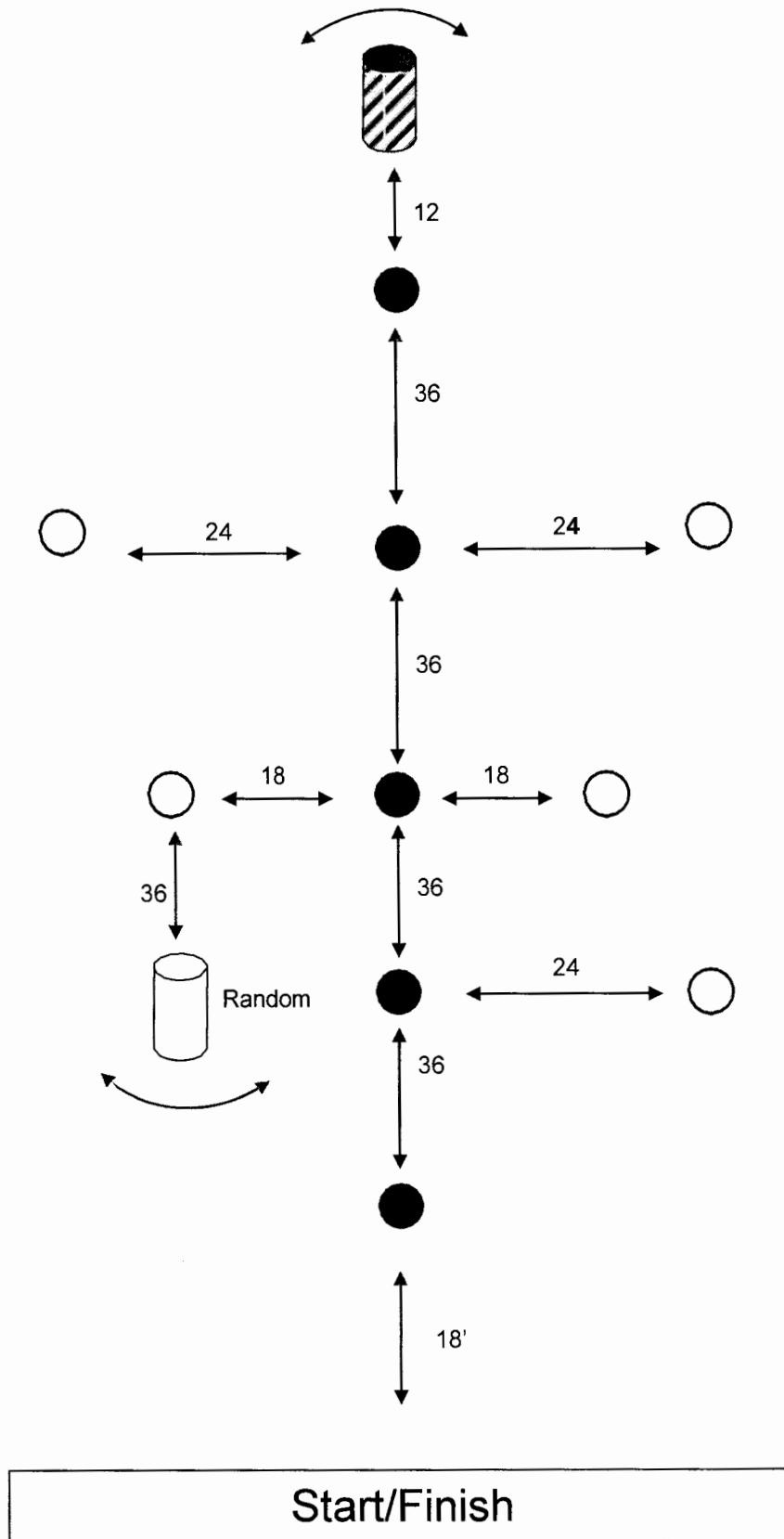

Course Rules

- 1) Shoot all light targets
- 2) Round random barrel
- 3) Proceed to and round rundown barrel
- 4) Shoot all dark targets

Pattern 17

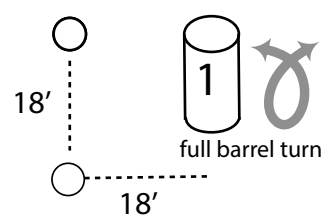
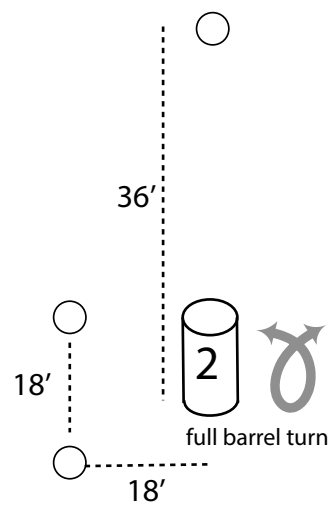
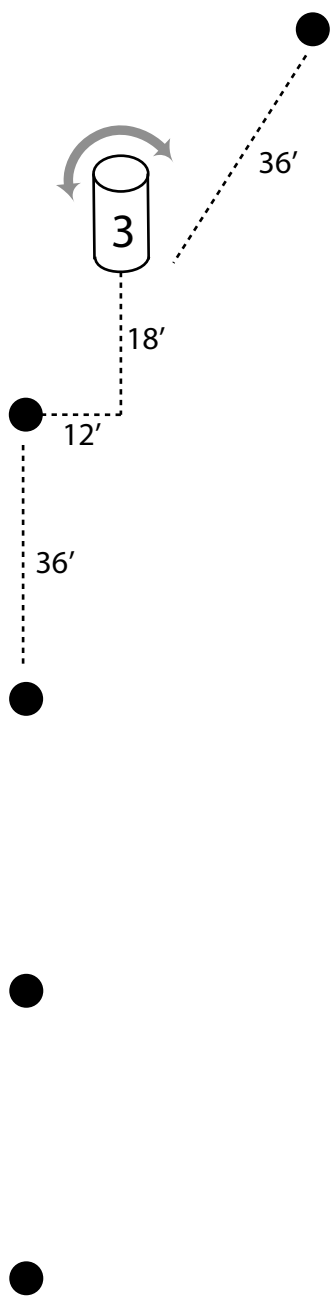

START/FINISH

Engage all light targets and execute full barrel turns on random barrels #1 and #2 first
 Round third random barrel while engaging dark targets

PROCEDURALS:

- failure to engage all light targets first
- failure to complete full barrel turns on first two barrels
- failure to round third random barrel

Pattern 18

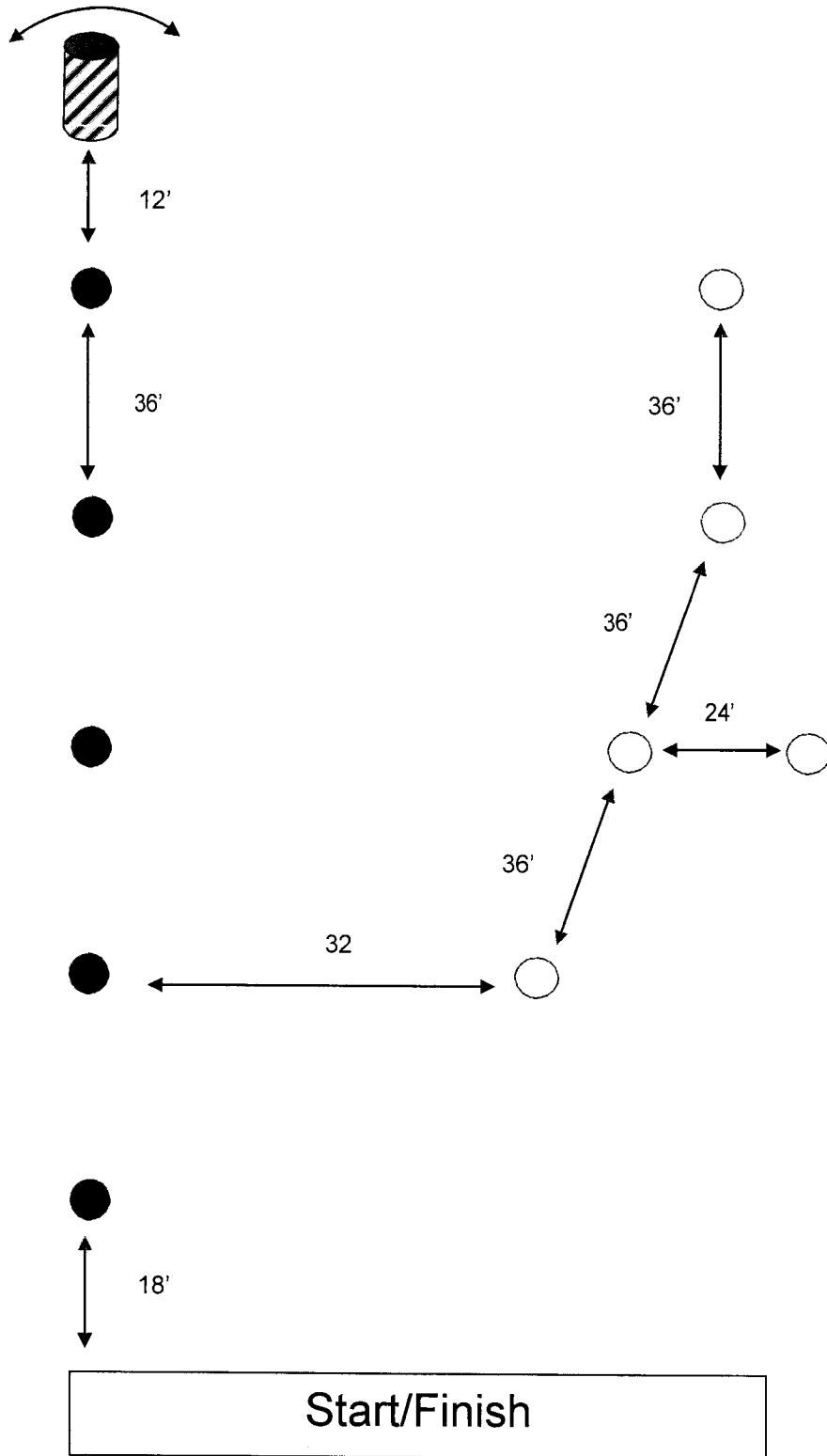

Course Rules

- 1) Spotlight targets first
- 2) Round rundown barrel
- 3) Shoot all dark targets

Pattern 19

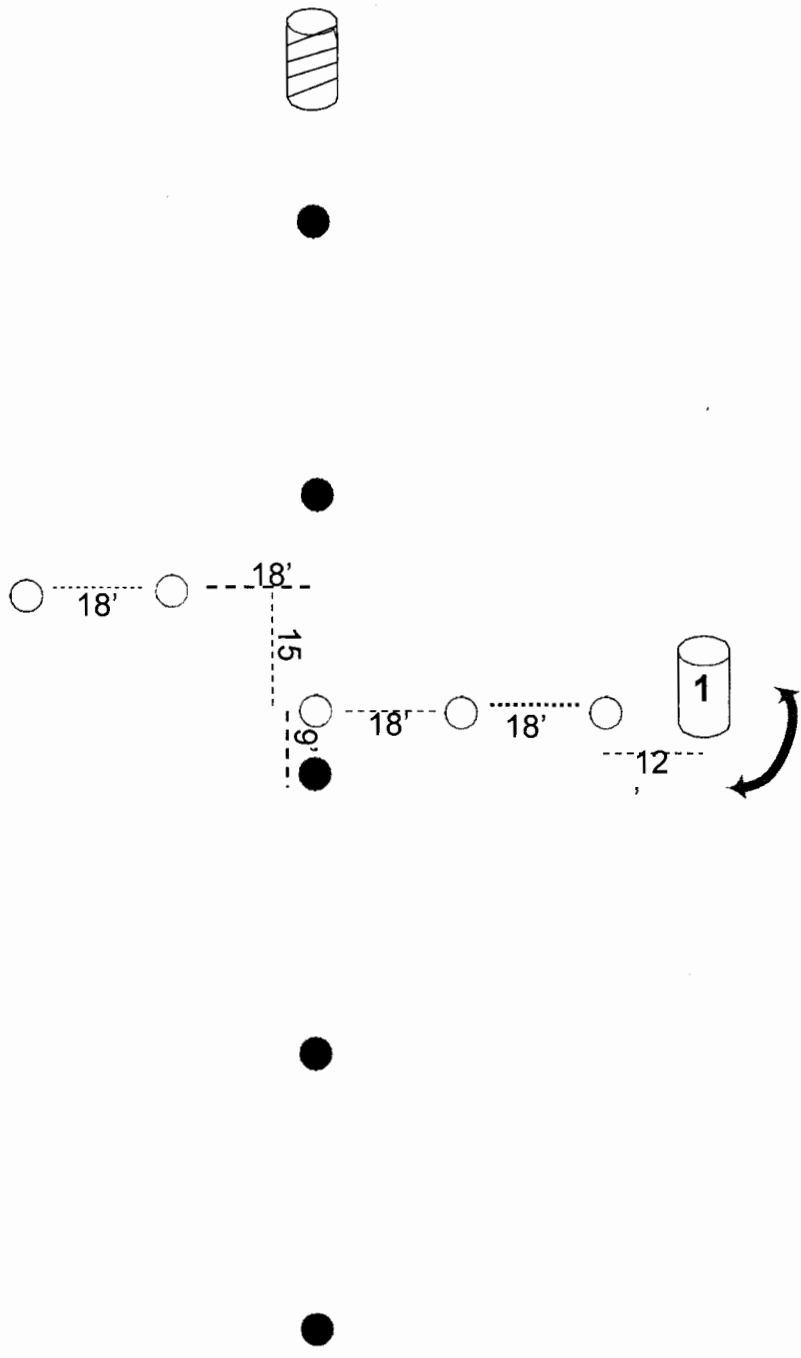

START/FINISH

- Round #1 Random Barrel first before engaging light targets
- Engage light targets
- Round rundown barrel
- Engage dark targets
- PROCEDURALS
- failure to round #1 random barrel first
- failure to engage all light targets before rounding rundown barrel
- failure to round rundown barrel

Pattern 20

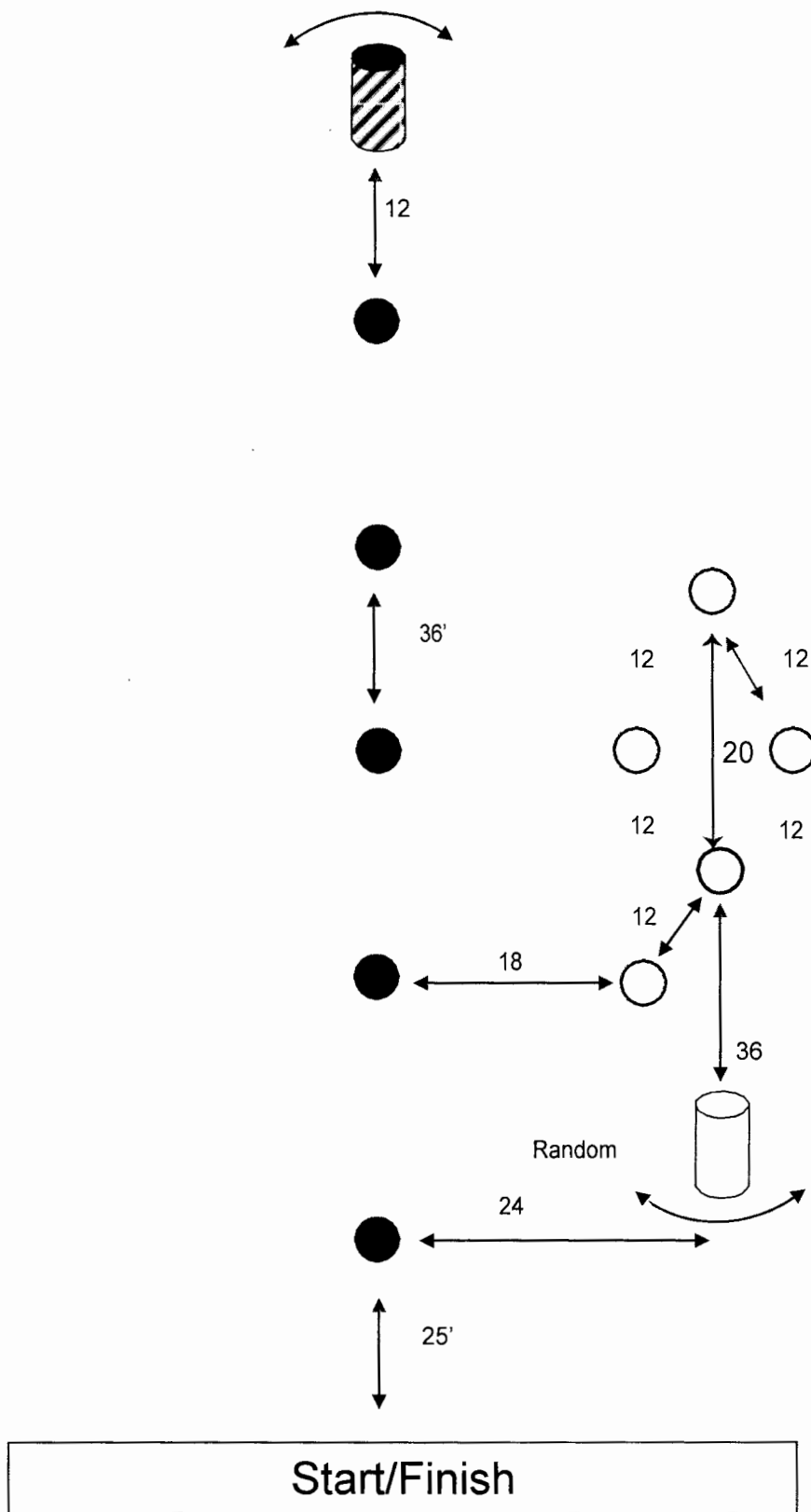

Course Rules

- 1) Shoot all light targets
- 2) Round random
- 3) Proceed to and round rundown barrel
- 4) Shoot all dark targets

Pattern 21

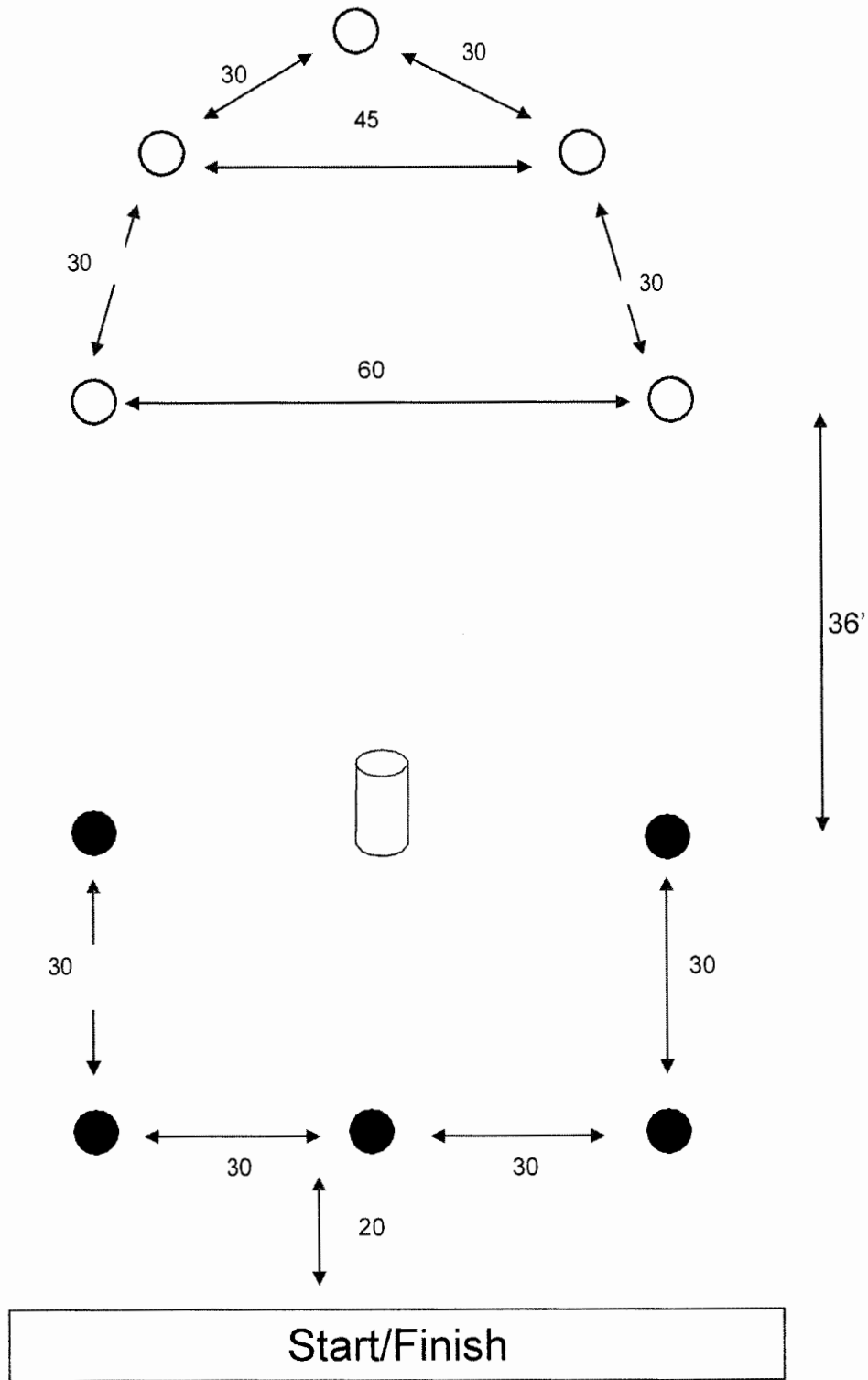

Course Rules

- 1) Shoot any color first
- 2) Round barrel last

Pattern 22

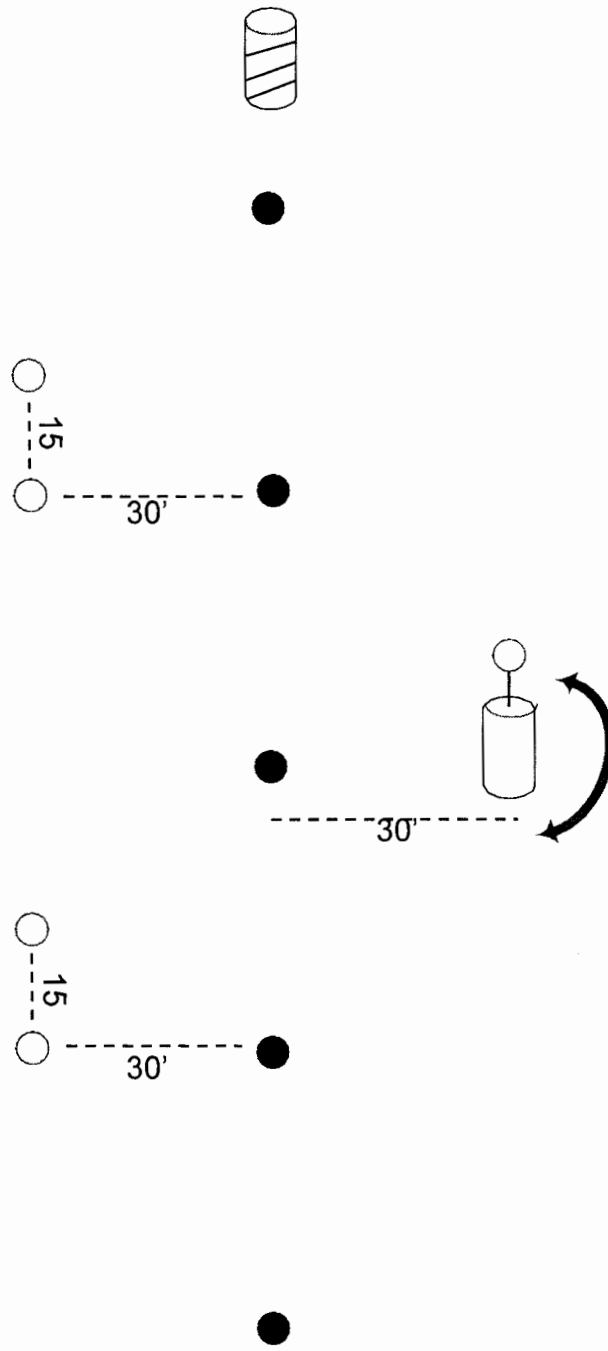

START/FINISH

Engage entire random course before rounding rundown barrel
 Round rundown barrel
 Engage all dark targets

PROCEDURALS

failure to engage all light targets before rounding rundown barrel
 failure to round random barrel
 failure to round rundown barrel

Pattern 23

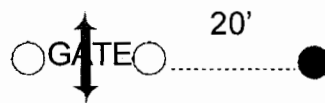
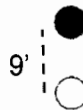
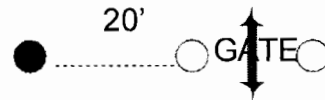

START/FINISH

Engage all light targets first

Round rundown barrel

Engage all dark targets

PROCEDURALS

failure to engage all light targets before rounding rundown barrel

failure to round rundown barrel

failure to pass through gates

Pattern 24

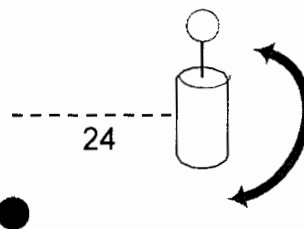
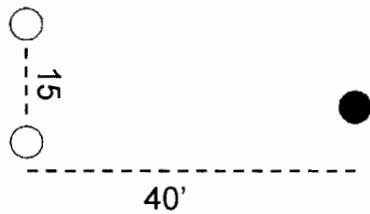
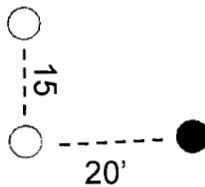

START/FINISH

Engage entire random course before rounding rundown barrel

Round rundown barrel

Engage all dark targets

PROCEDURALS

failure to engage all light targets before rounding rundown barrel

failure to round random barrel

failure to round rundown barrel

Pattern 25

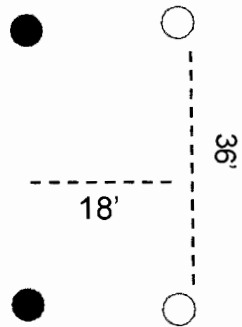
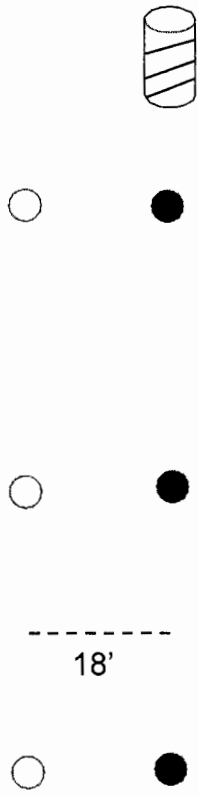

START/FINISH

Engage all light targets before rounding rundown barrel

Round rundown barrel

Engage all dark targets

PROCEDURALS

failure to engage all light targets before rounding rundown barrel

failure to round rundown barrel

Pattern 26

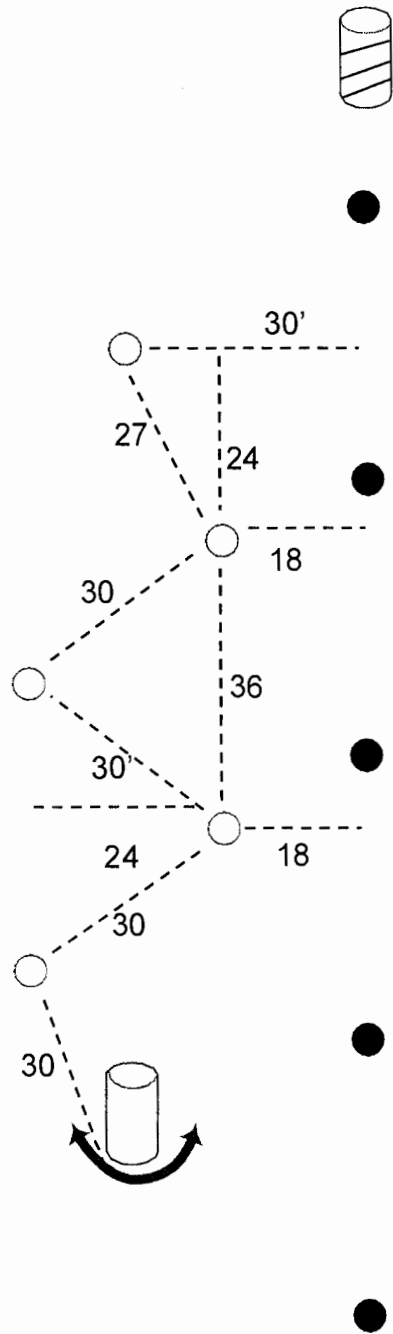

START/FINISH

Engage all light targets before rounding the random barrel
 Round rundown barrel
 Engage all dark targets

PROCEDURALS:

failure to engage all light targets before rounding random barrel
 failure to round random barrel
 failure to round rundown barrel

Pattern 27

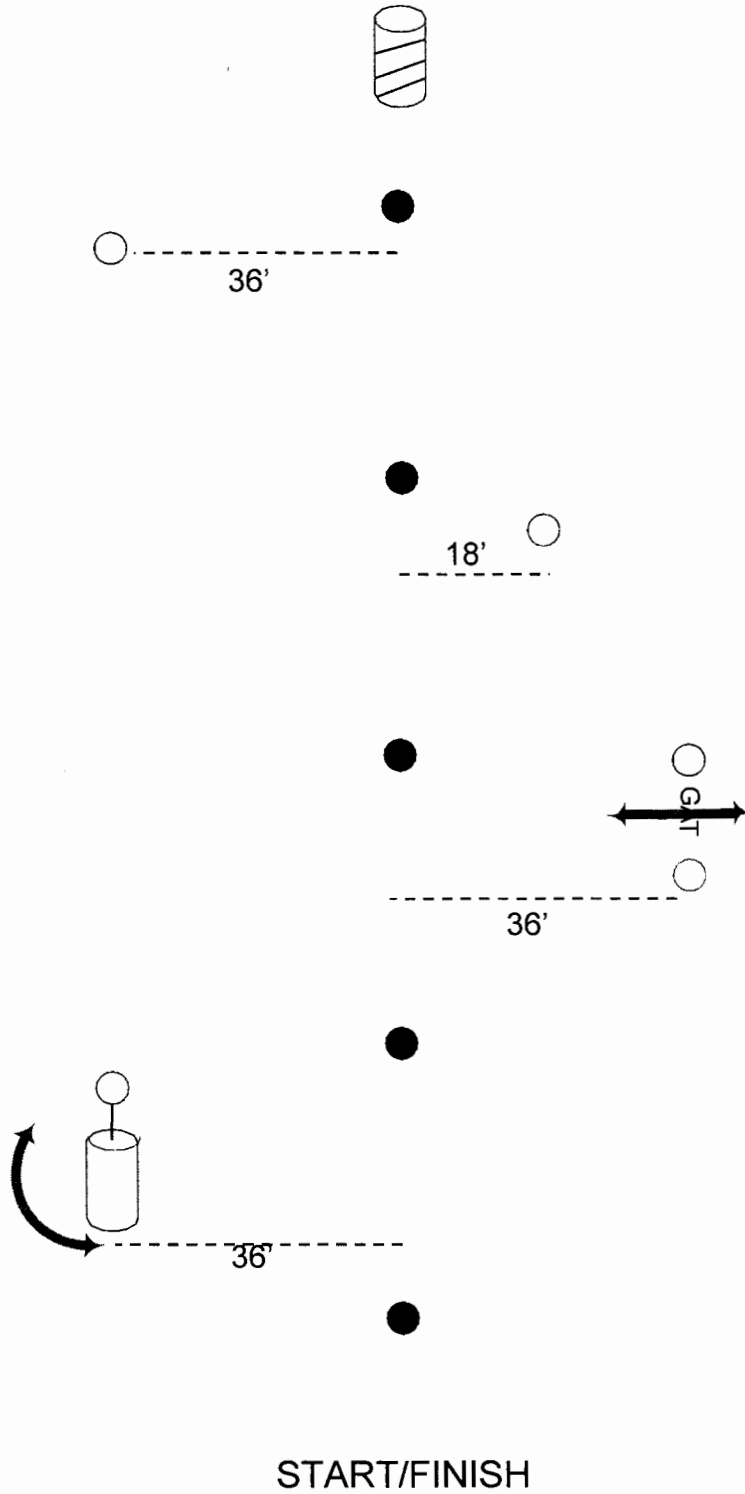

Engage entire random course before rounding rundown barrel

Round rundown barrel

Engage all dark targets

PROCEDURALS:

failure to engage all light targets before rounding rundown barrel

failure to round random barrel

failure to round rundown barrel

Pattern 28

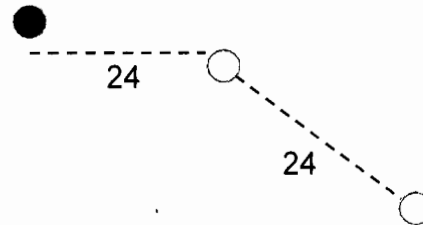
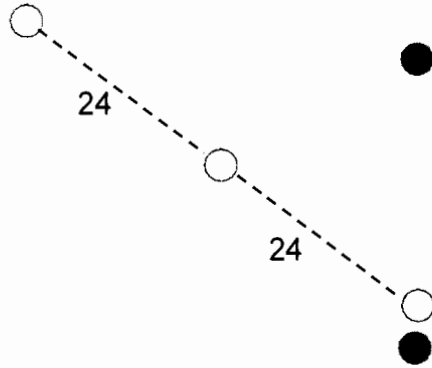

START/FINISH

Engage all light targets before rounding the rundown barrel
Round rundown barrel
Engage all dark targets

PROCEDURALS:

failure to engage all light targets before rounding rundown barrel
failure to round rundown barrel

Pattern 29

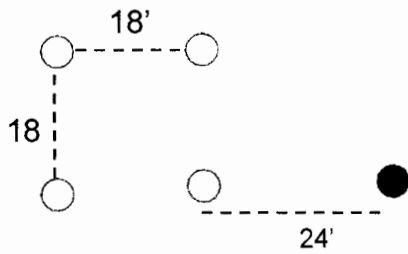

36'



START/FINISH

Engage all light targets before rounding rundown barrel

Round rundown barrel

Engage all dark targets

PROCEDURALS:

failure to engage all light targets before rounding rundown barrel

failure to round rundown barrel

Pattern 30

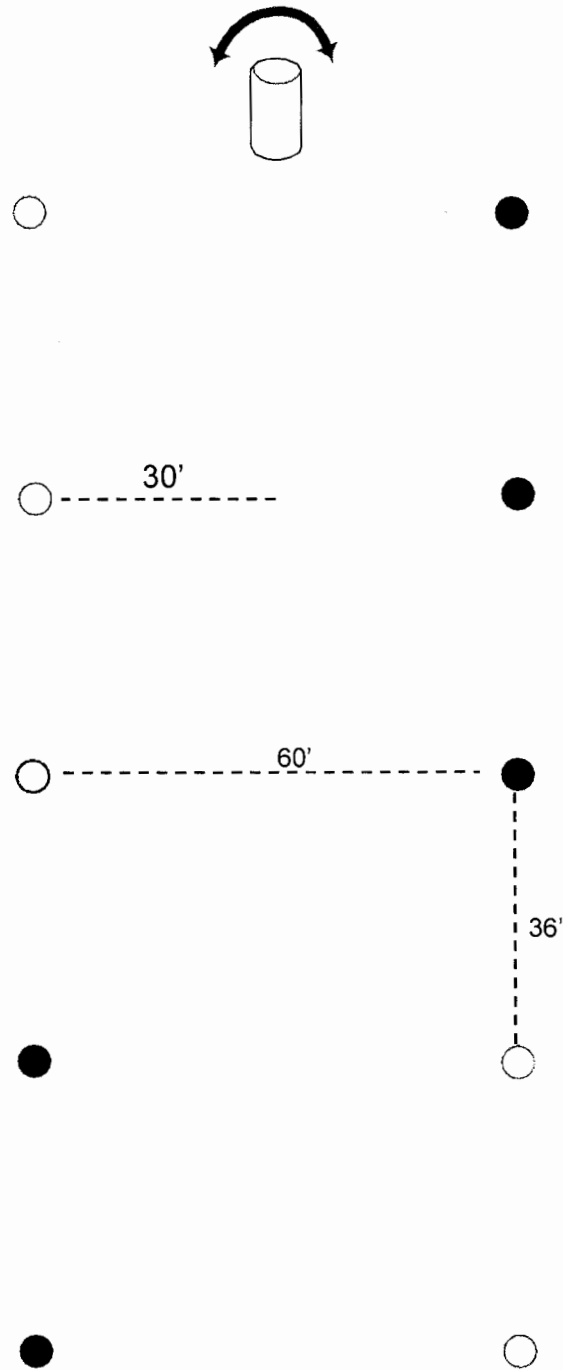

START/FINISH

Engage all targets of one color before rounding the random barrel
 Round random barrel

Engage all targets of the second color

PROCEDURALS:

failure to engage all targets of one color before rounding random barrel

failure to round random barrel

Pattern 31

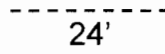
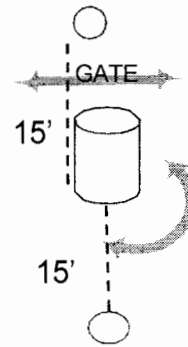
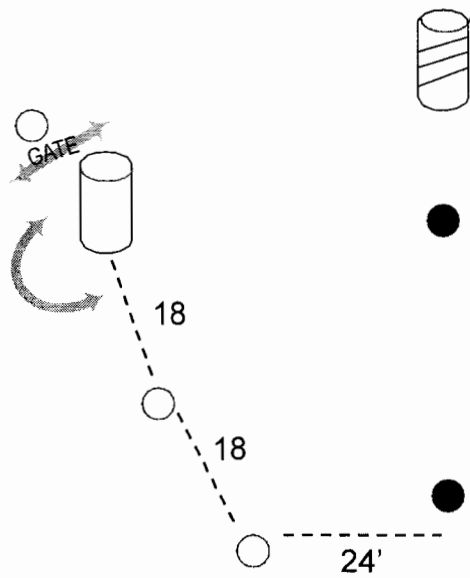

START/FINISH

- Engage light targets first
- Round random barrels while engaging light targets
- Round rundown barrel
- Engage dark targets
- PROCEDURALS:
- failure to engage light targets first
- failure to round random barrels
- failure to pass through gates
- failure to round rundown barrel

Pattern 32

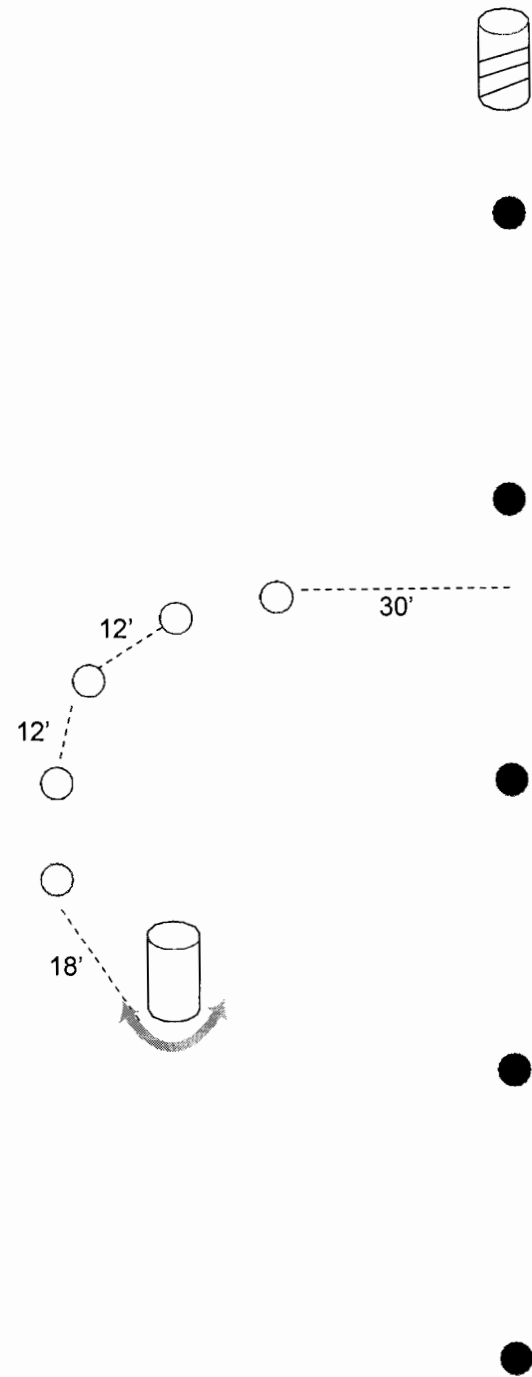

START/FINISH

Engage light targets before rounding the random barrel

Round rundown barrel

Engage dark targets

PROCEDURALS:

failure to engage light targets first

failure round random barrel

failure to round rundown barrel

Pattern 33

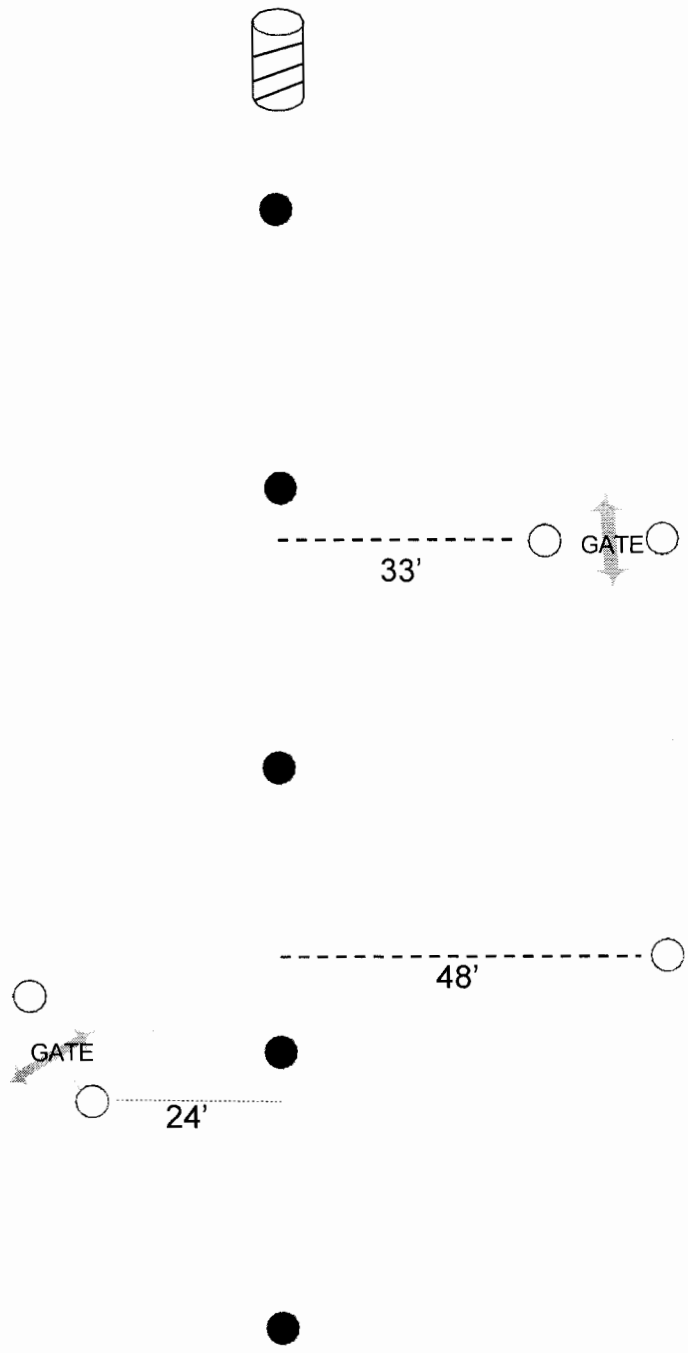

Engage all light targets before rounding the rundown barrel
 Round rundown barrel
 Engage all dark targets

PROCEDURALS:

- failure to engage all light targets before rounding rundown barrel
- failure to pass through gates
- failure to round rundown barrel

Pattern 34

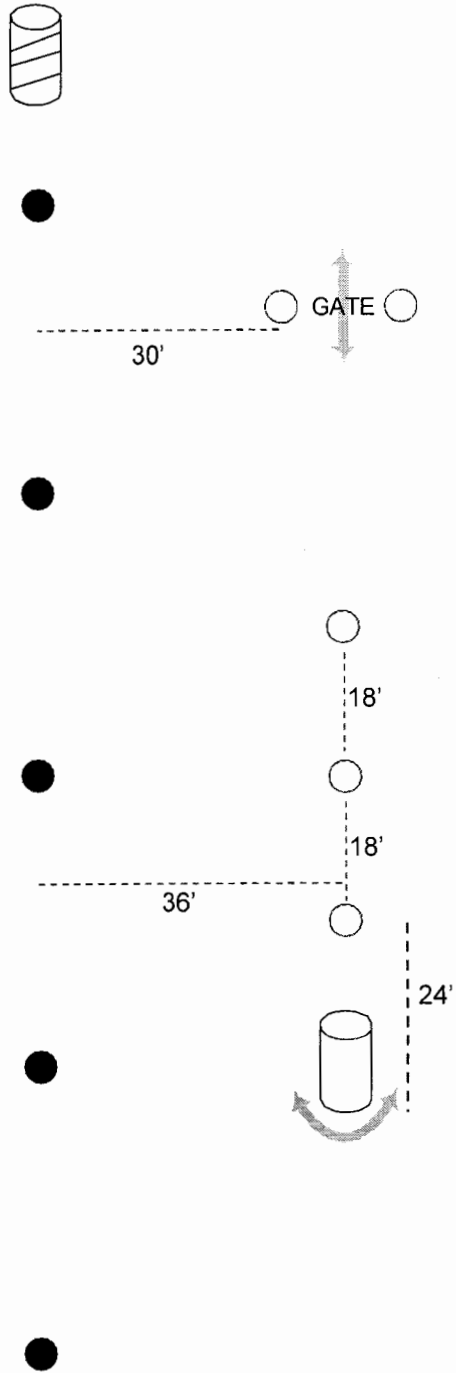

START/FINISH

Engage light targets before rounding the random barrel

Round rundown barrel

Engage dark targets

PROCEDURALS:

failure to engage light targets first

failure round random barrel

failure to round rundown barrel

Pattern 35



①

30'

36'

18'

18'

12'

36'



START/FINISH

Engage #1 light balloon, then engage remainder of light targets

Round random barrel

Round rundown barrel

Engage dark targets

PROCEDURALS:

failure to engage #1 balloon first

failure to engage light targets before rounding random barrel

failure round random barrel

failure to round rundown barrel

Pattern 36



30'

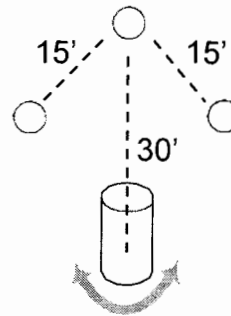

START/FINISH

Engage either of the #1 light balloons, then engage remainder of light targets

Round random barrel

Round rundown barrel

Engage dark targets

PROCEDURALS:

failure to engage #1 balloon first

failure to engage light targets before rounding random barrel

failure round random barrel

failure to round rundown barrel

Pattern 37

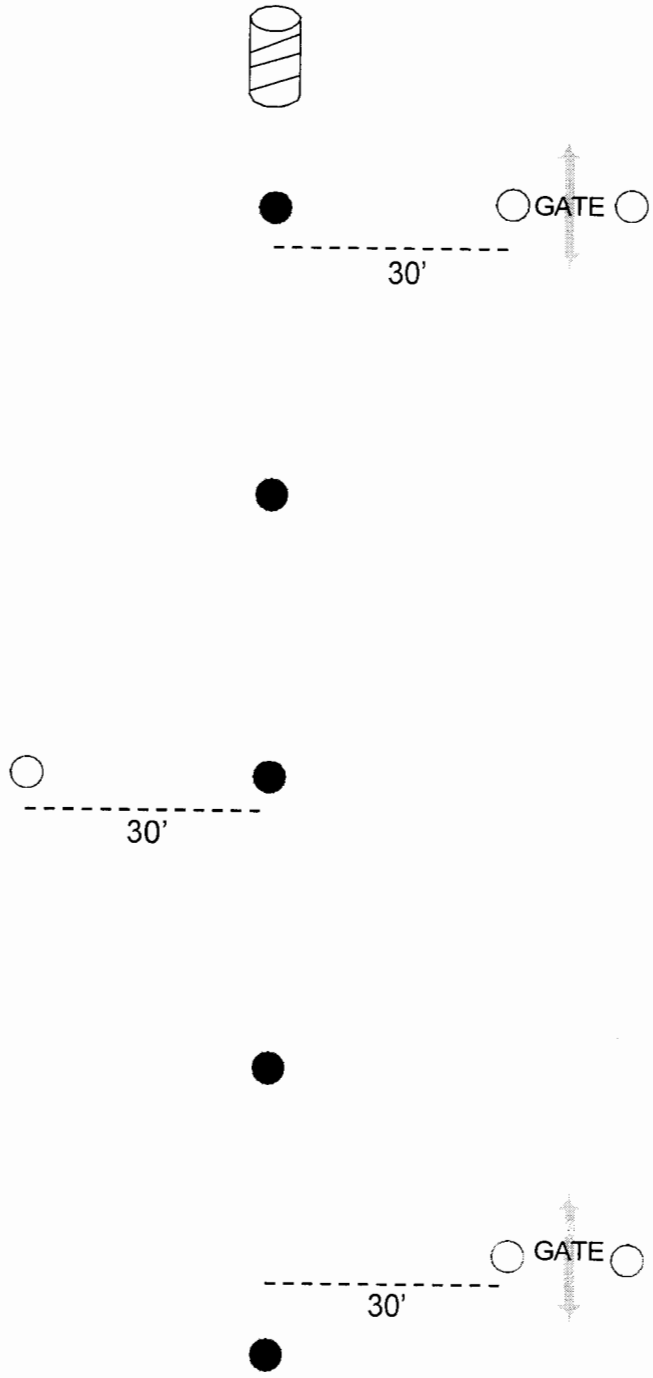

START/FINISH

- Engage light targets before rounding the rundown barrel
- Round rundown barrel
- Engage dark targets
- PROCEDURALS:
- failure to engage light targets before rounding rundown barrel
- failure to pass through gates
- failure to round rundown barrel

Pattern 38

Mounted Shooters of America



Rifle/Shotgun
Certified
Patterns

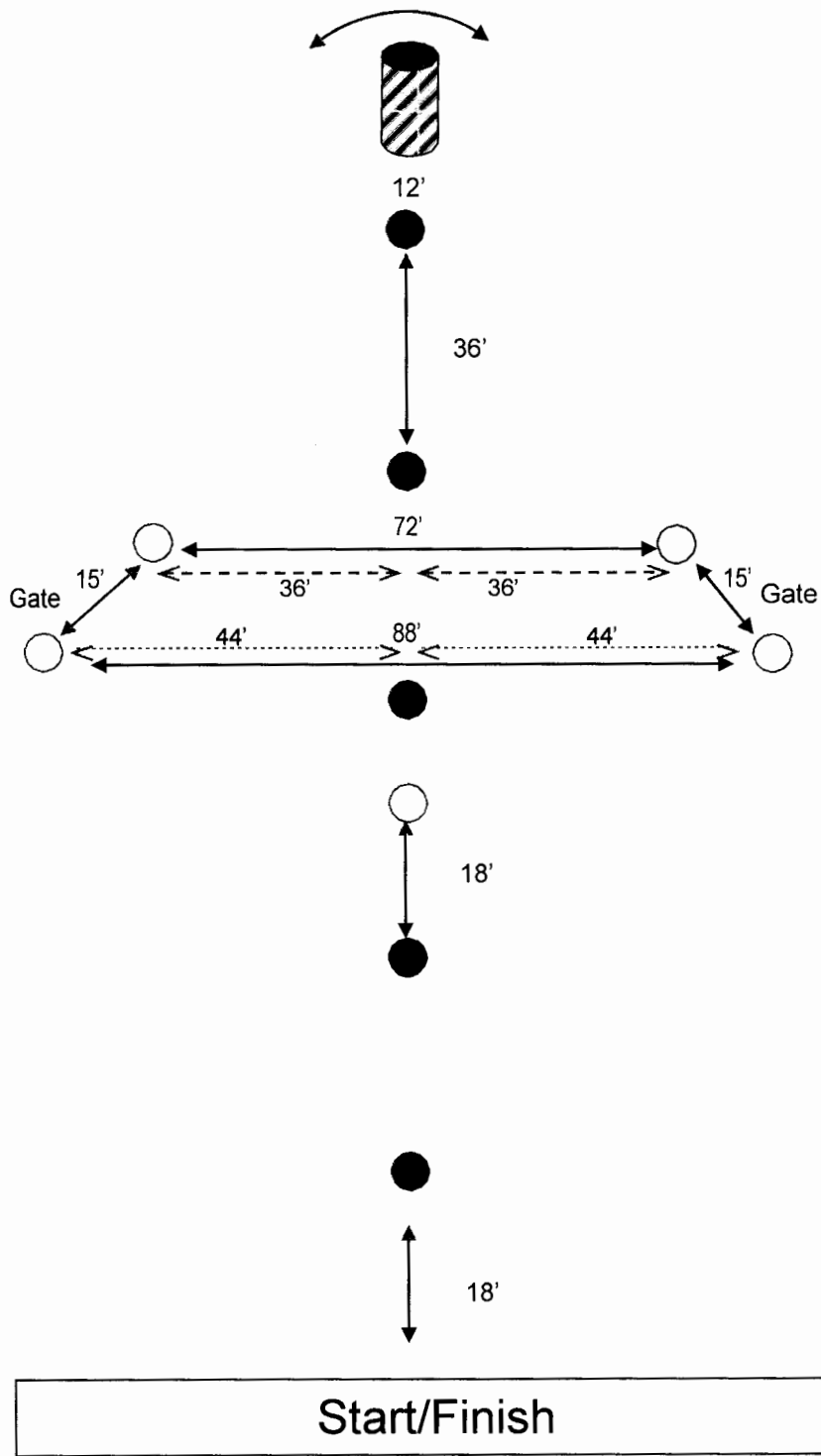

Course Rules

- 1) Shoot all light targets
- 2) Round rundown barrel
- 3) Shoot all dark targets

Pattern 39
*Rifle, Shotgun

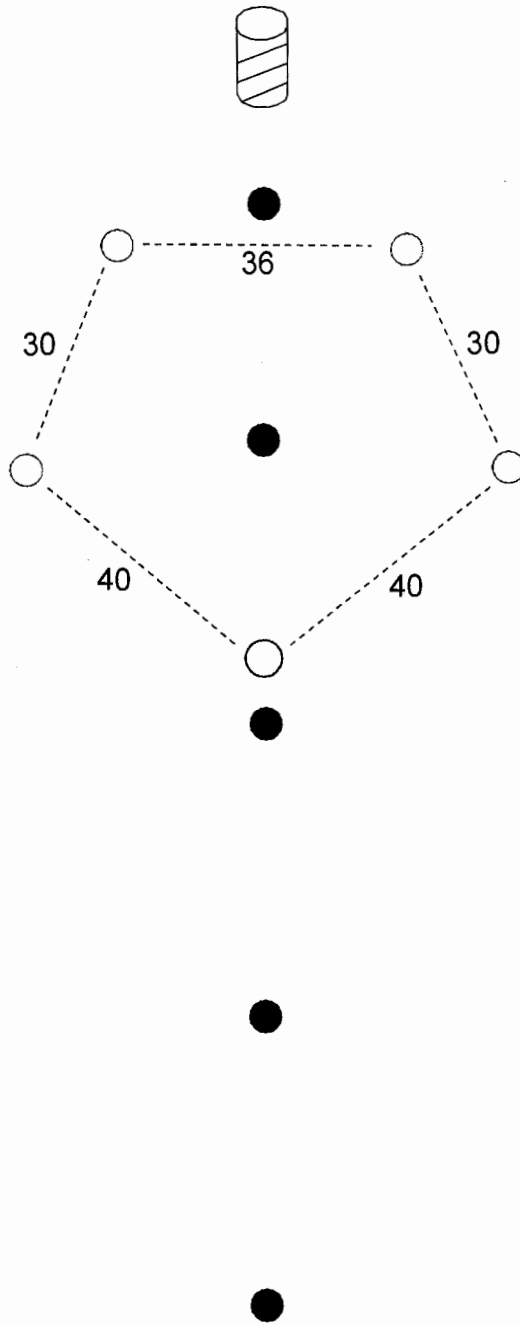

START/FINISH

Engage all light targets first

Round rundown barrel

Engage dark targets

PROCEDURALS

failure to engage all light targets before rounding rundown barrel

failure to round rundown barrel

Pattern 40
Rifle/Shotgun
Course

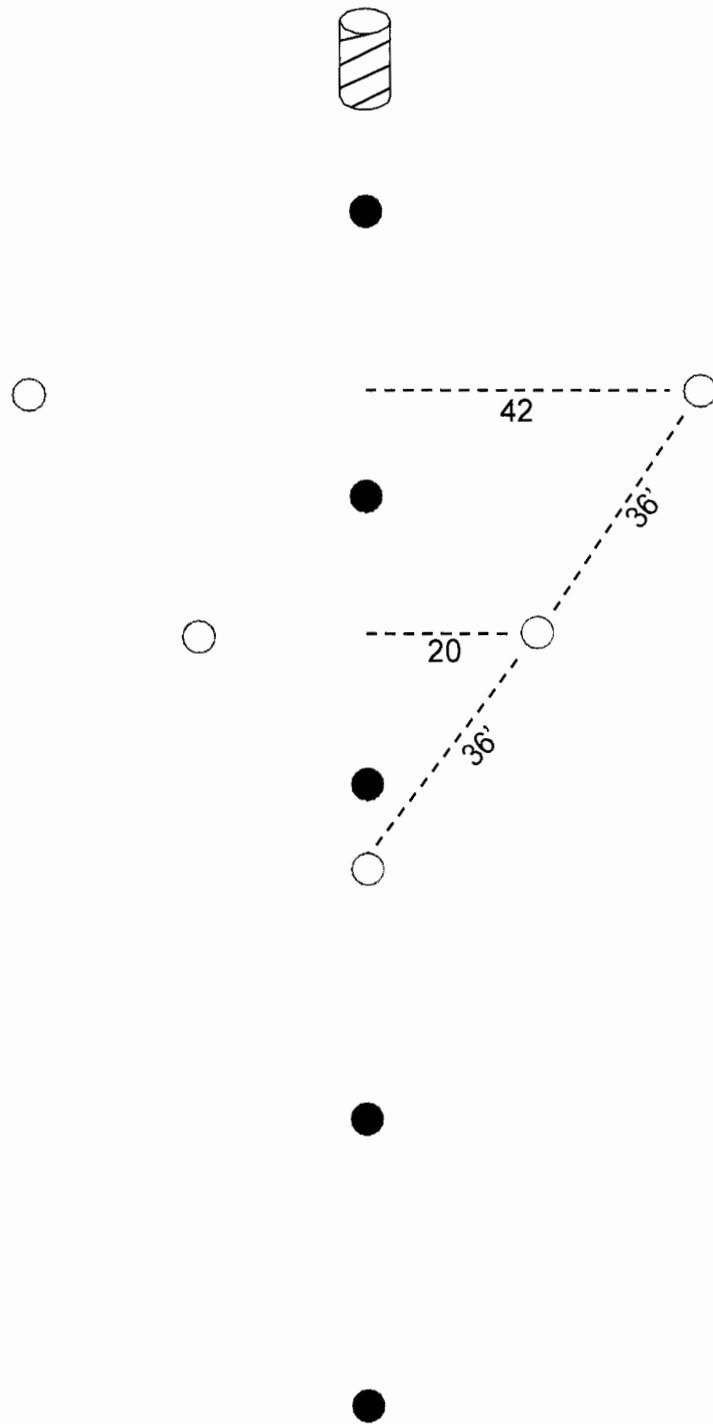

START/FINISH

Engage all light targets first
 Round rundown barrel
 Engage dark targets
PROCEDURALS
 failure to engage all light targets before rounding rundown barrel
 failure to round rundown barrel

Pattern 41
 Rifle/Shotgun
 Course

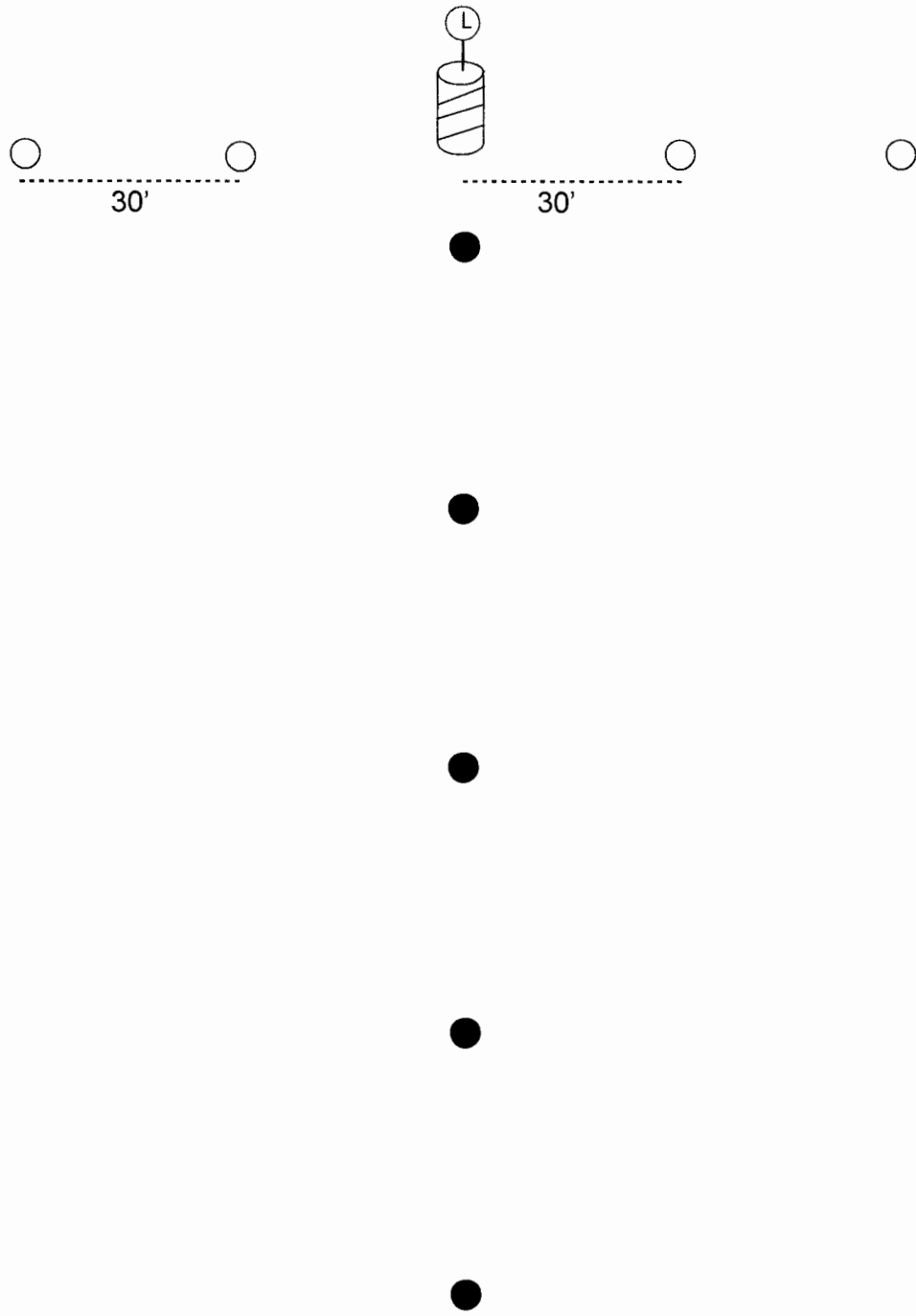

START/FINISH

Engage light targets, shooting light target on top of rundown barrel last, before rounding the rundown barrel

Round rundown barrel

Engage dark targets

PROCEDURALS:

failure to engage light targets before rounding rundown barrel

failure to engage light target on top of barrel last

failure to round rundown barrel

Pattern 42
Rifle/Shotgun
Engage Light
Targets in Any
Order

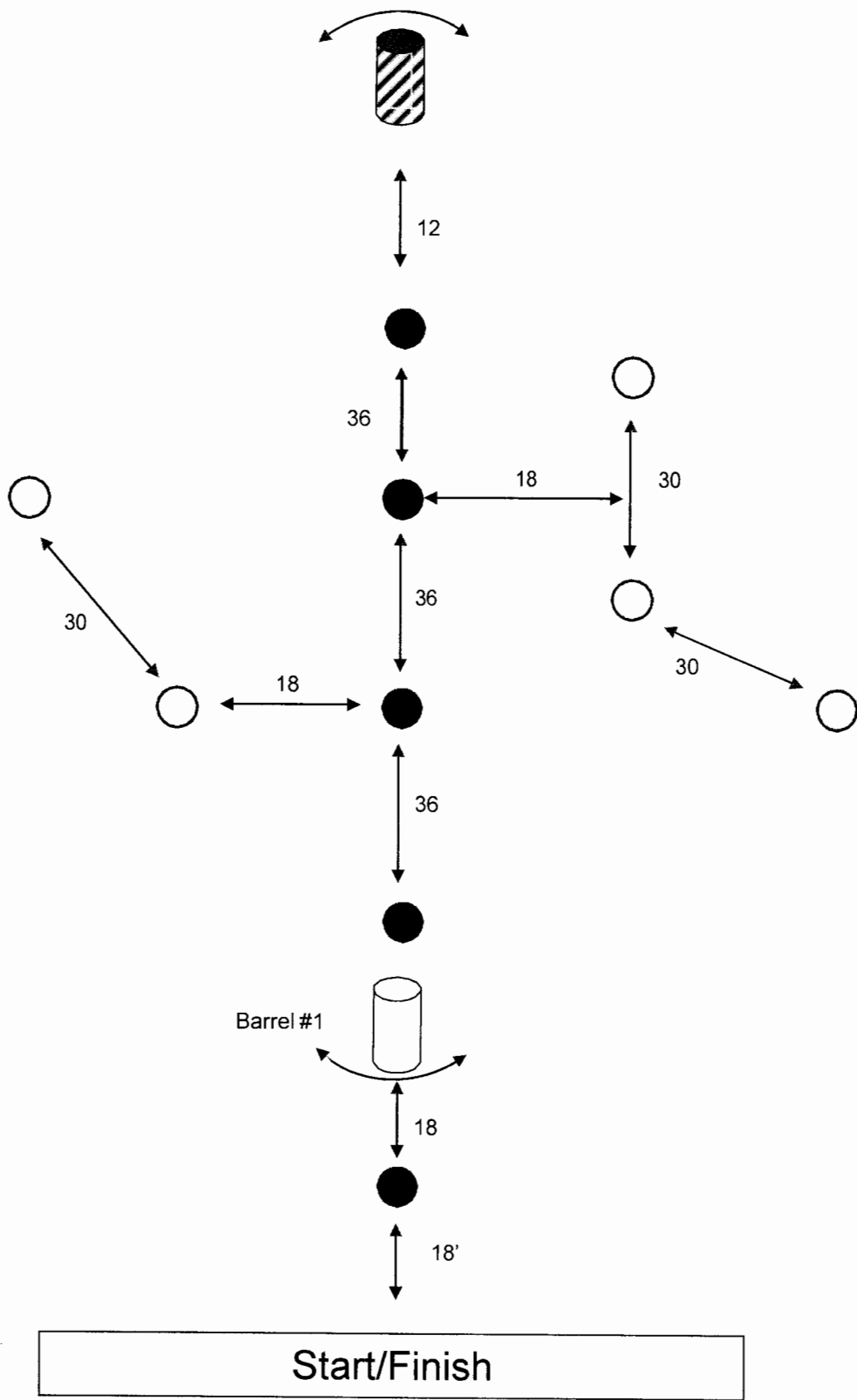

Course Rules

- 1) Shoot all light targets
- 2) Round barrel #1
- 3) Proceed to and round rundown barrel
- 4) Shoot all dark targets

Pattern 43
*Rifle & Shotgun

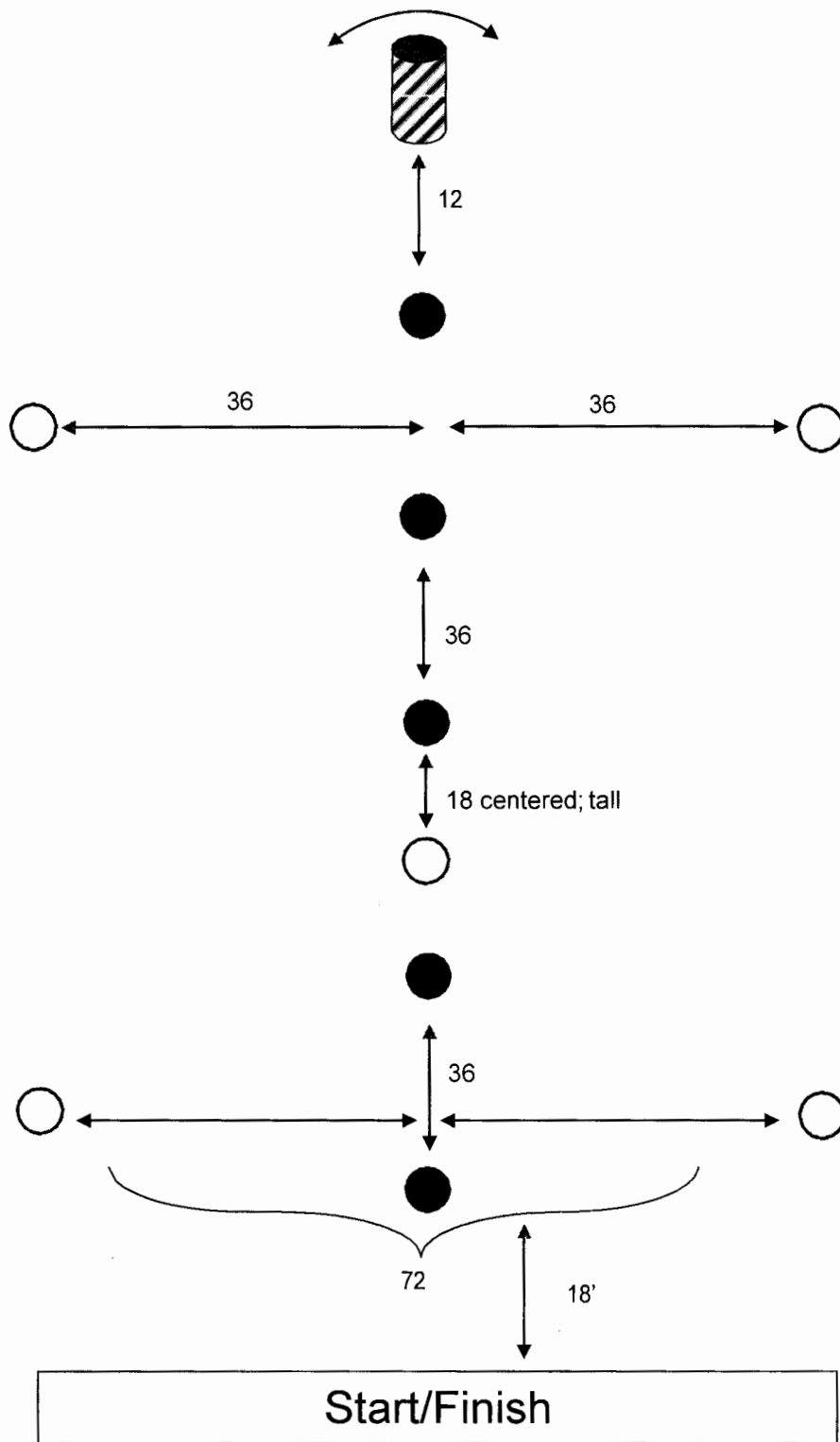

Course Rules

- 1) Shoot all light targets
- 2) Proceed to and round rundown barrel
- 3) Shoot all dark targets

Pattern 44
*Rifle & Shotgun

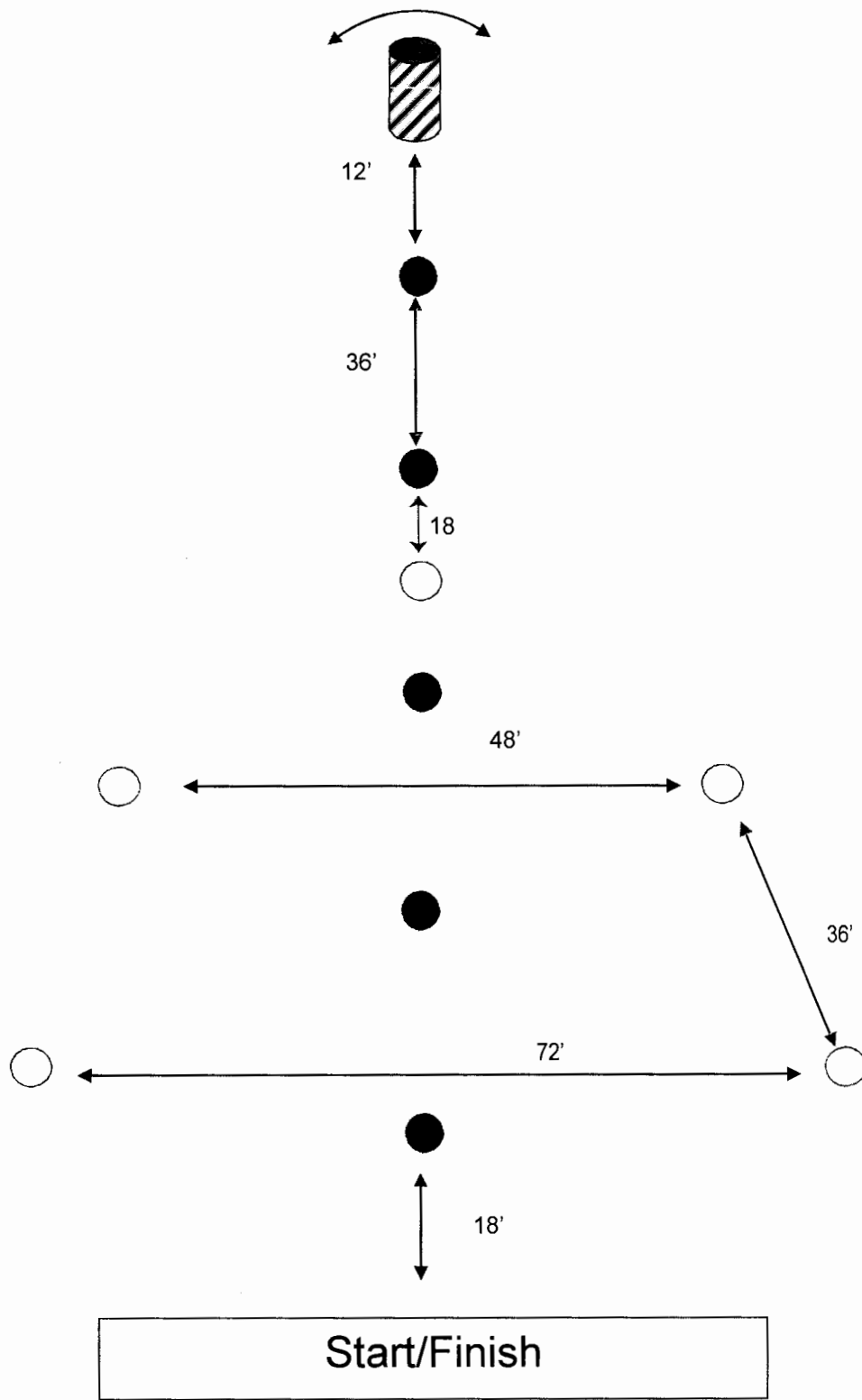

Course Rules

- 1) Shoot all light targets
- 2) Round rundown barrel
- 3) Shoot all dark targets

Pattern 45
Rifle/Shotgun

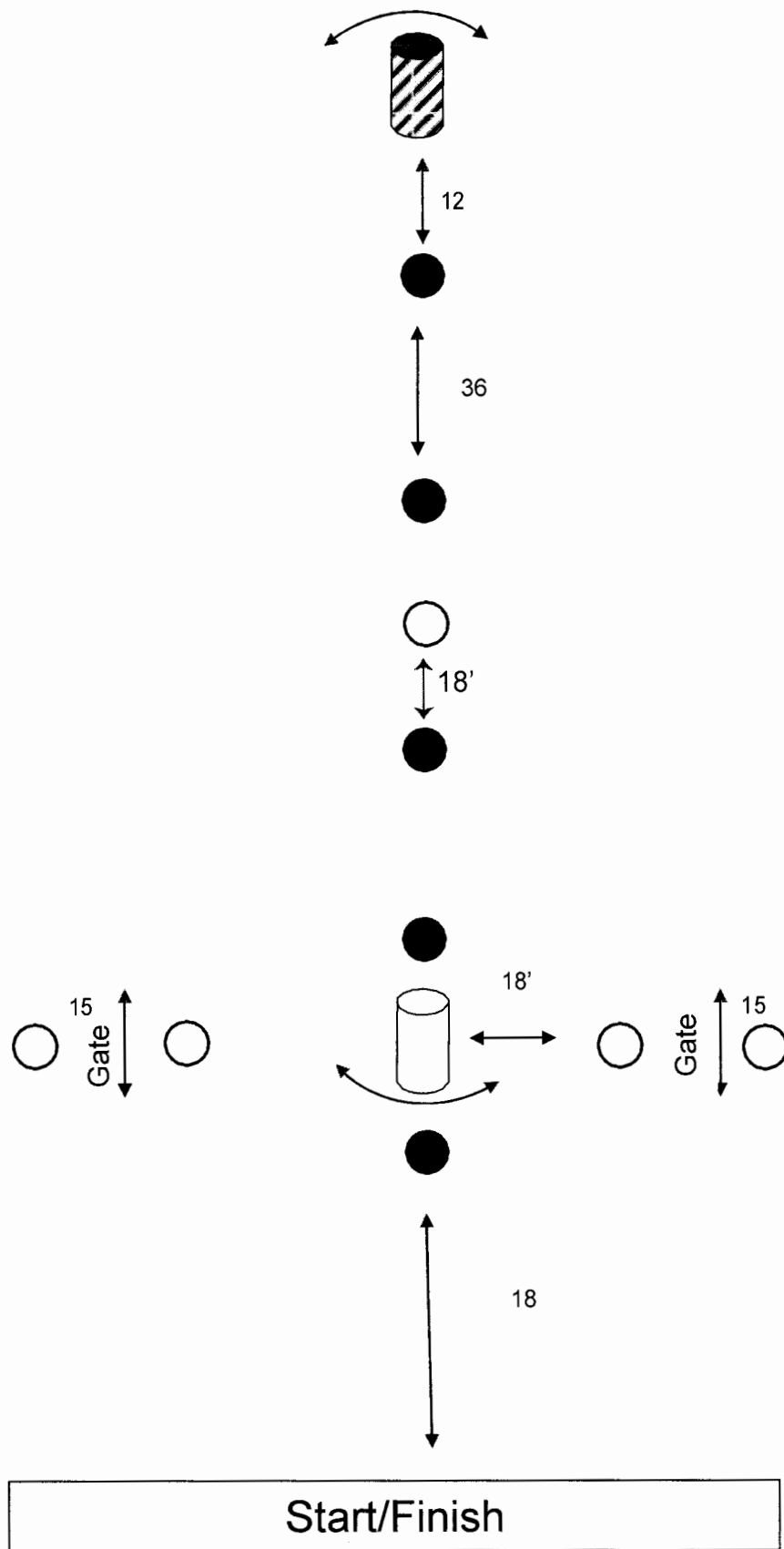

Course Rules

- 1) Shoot the entire random course
- 2) Round the rundown barrel
- 3) Shoot all dark targets

Pattern 46
*Rifle & Shotgun

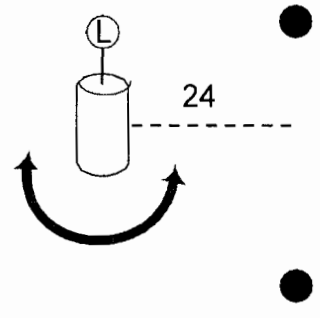
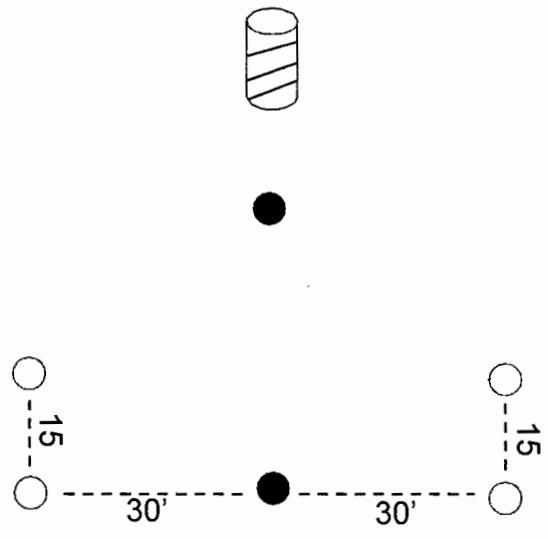

START/FINISH

Engage light targets first, shooting LAST balloon on top of random barrel last.
 Round random barrel then round rundown barrel
 Engage all dark targets
PROCEDURALS
 failure to follow prescribed course of fire
 failure to round random barrel
 failure to round rundown barrel

Pattern 47
 Rifle/Shotgun
 Course

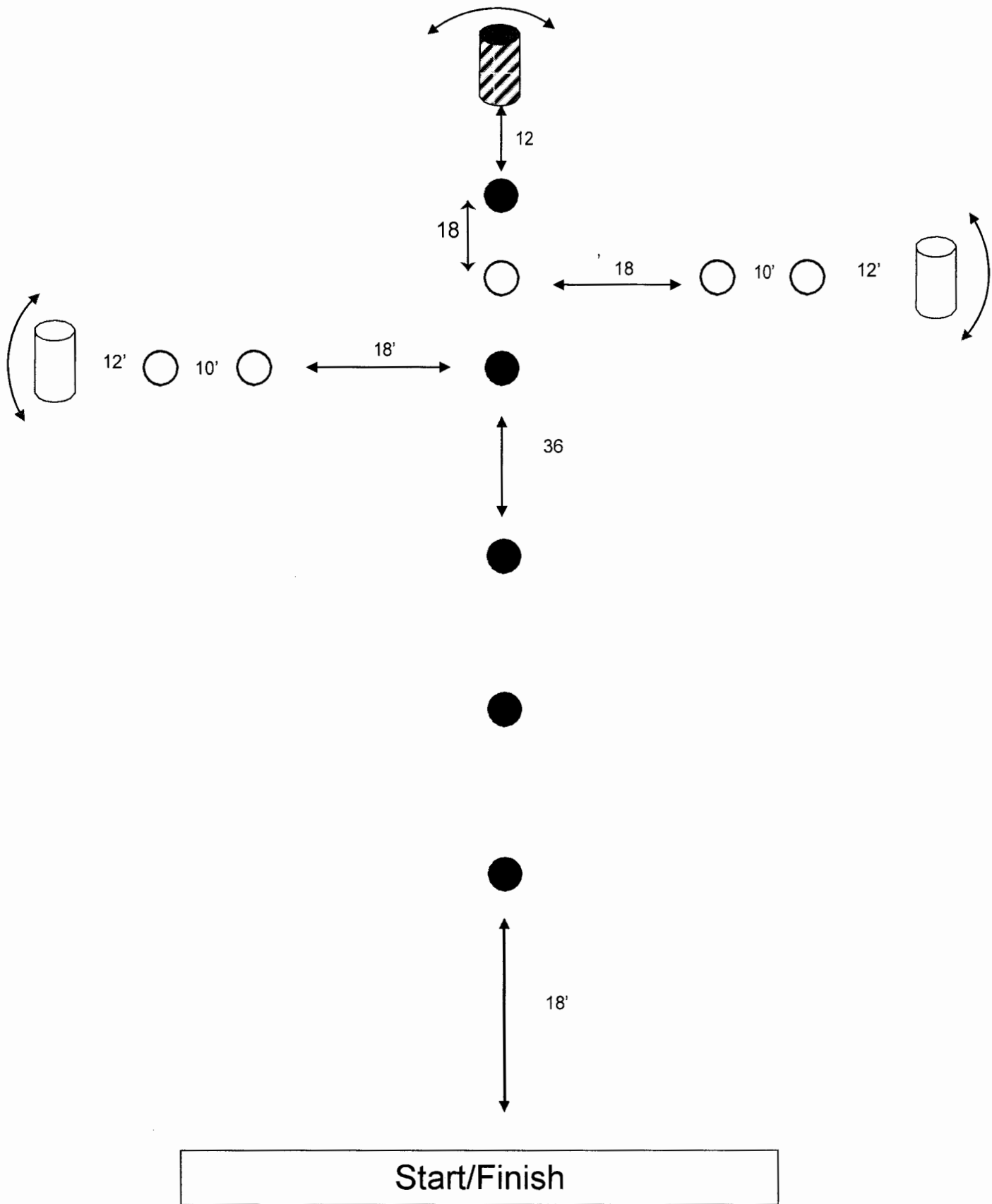

Course Rules

- 1) Shoot all the random course
- 2) Round the rundown barrel
- 3) Shoot all dark targets

Pattern 48
 *Rifle & Shotgun
CERTIFIED
COURSE

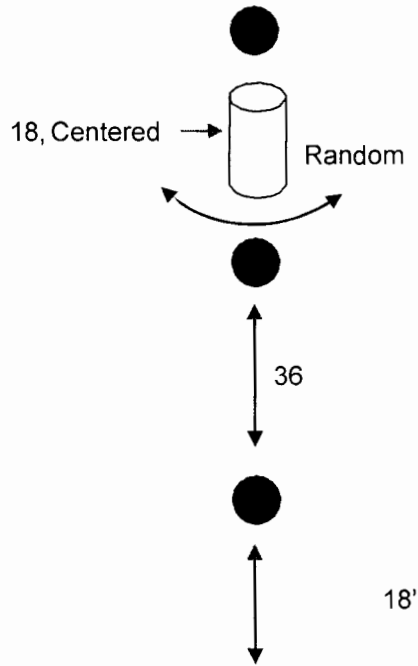
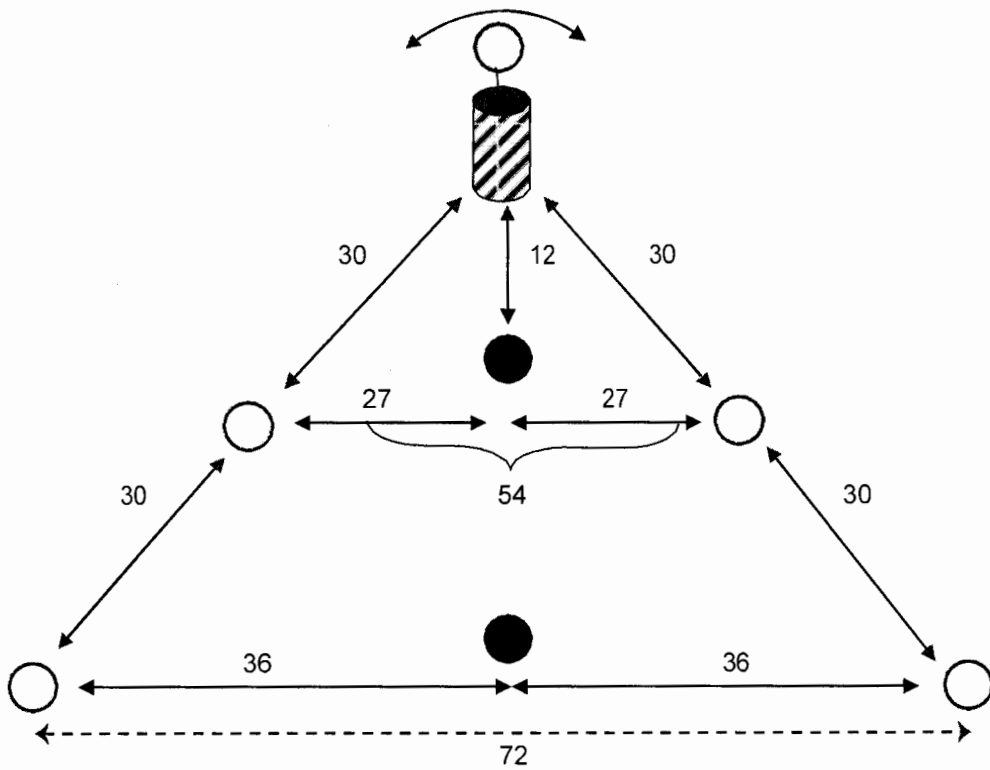

Course Rules

- 1) Shoot all light targets—MUST stay on the outside of all 5 light targets
- 2) Round random barrel
- 3) Proceed to and round rundown barrel
- 4) Shoot all dark targets

Pattern 49
Rifle/Shotgun
CERTIFIED
COURSE

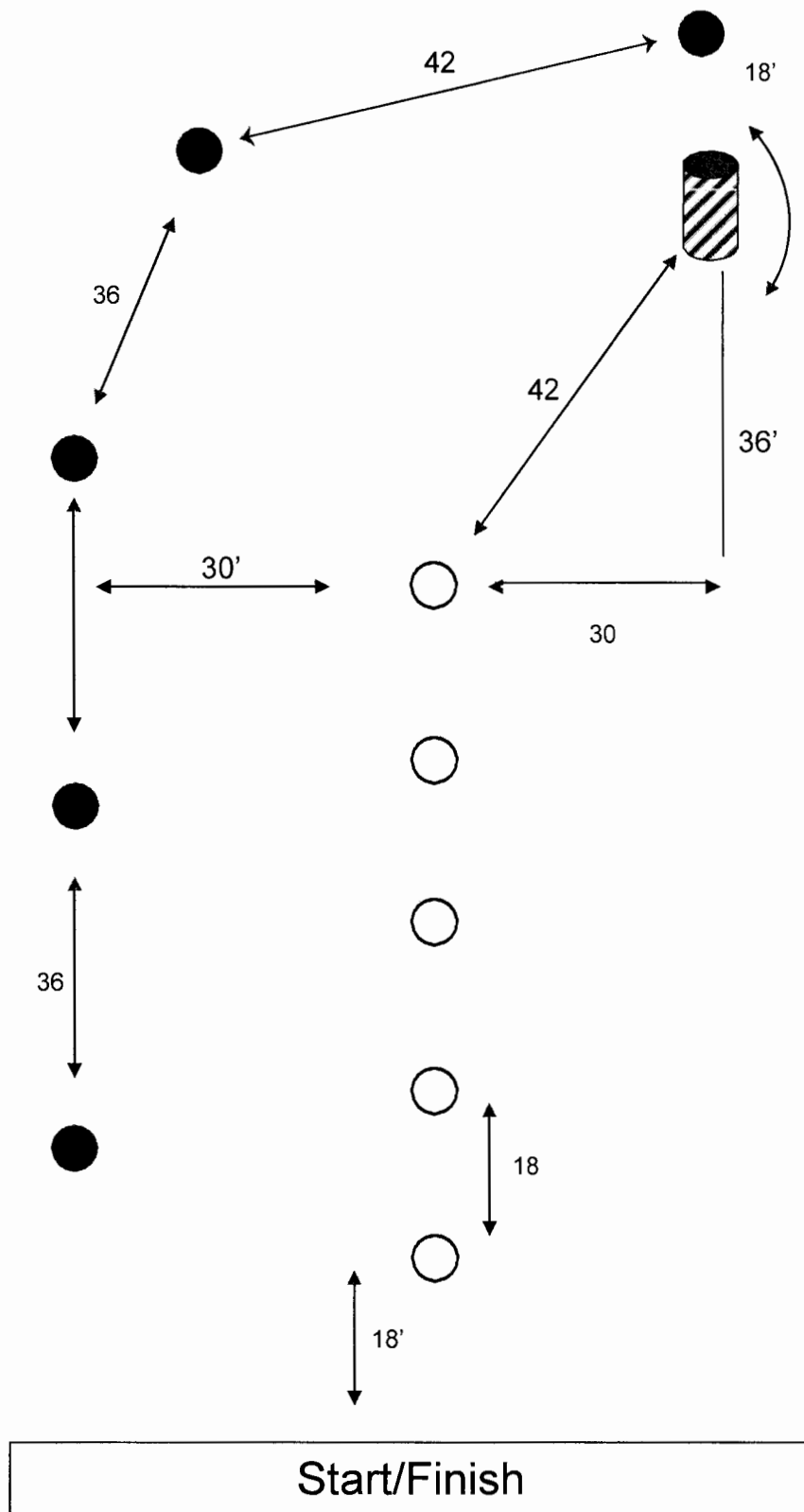

Course Rules

- 1) Shoot all of the light targets first
- 2) Round rundown barrel
- 3) Shoot all targets of the remaining color

Pattern 50
 CERTIFIED
 COURSE

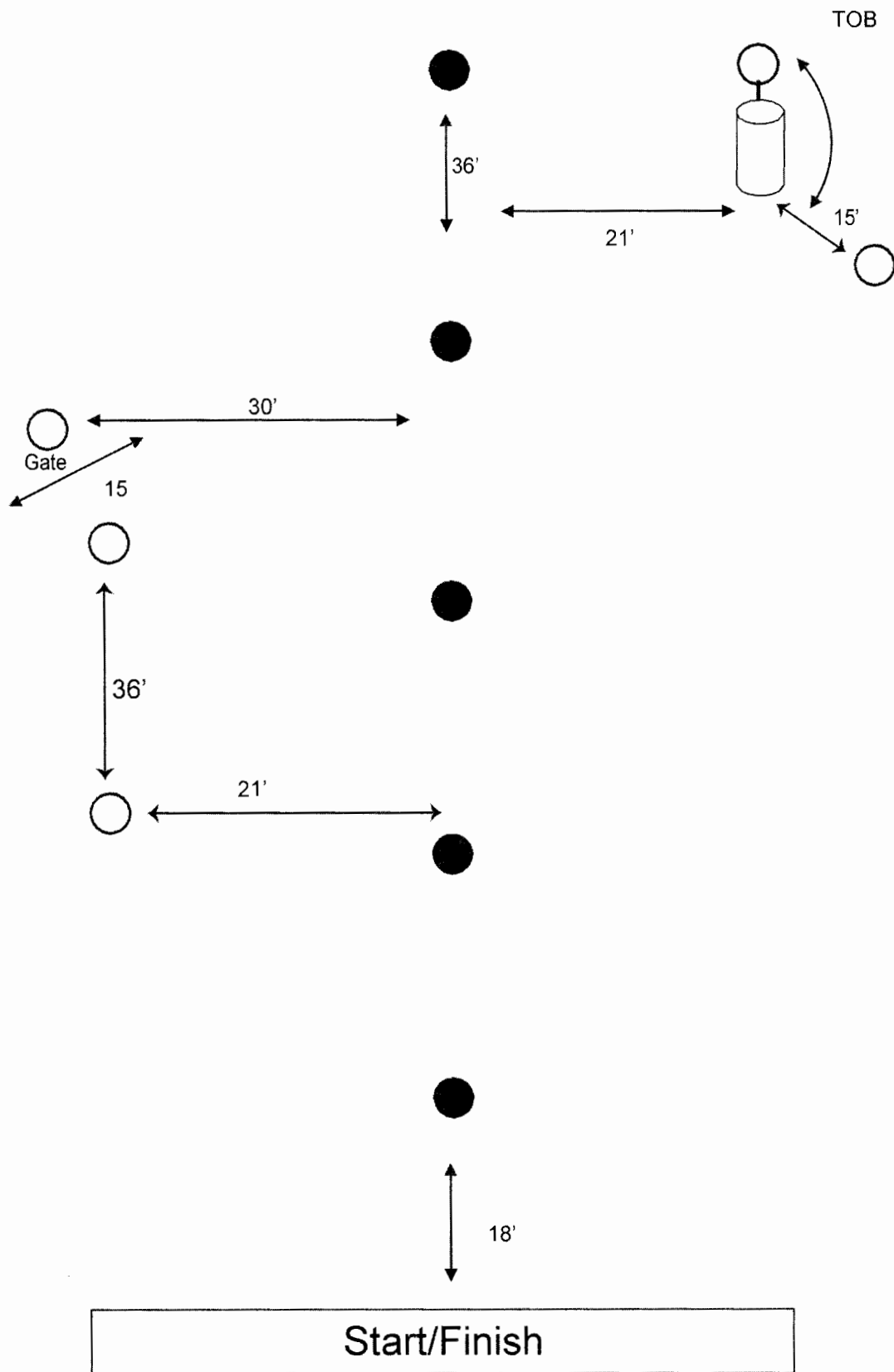

Course Rules

- 1) Shoot all of the light targets first
- 2) Proceed to go round random barrel
- 5) Shoot all dark targets

Pattern 51
 CERTIFIED
 COURSE

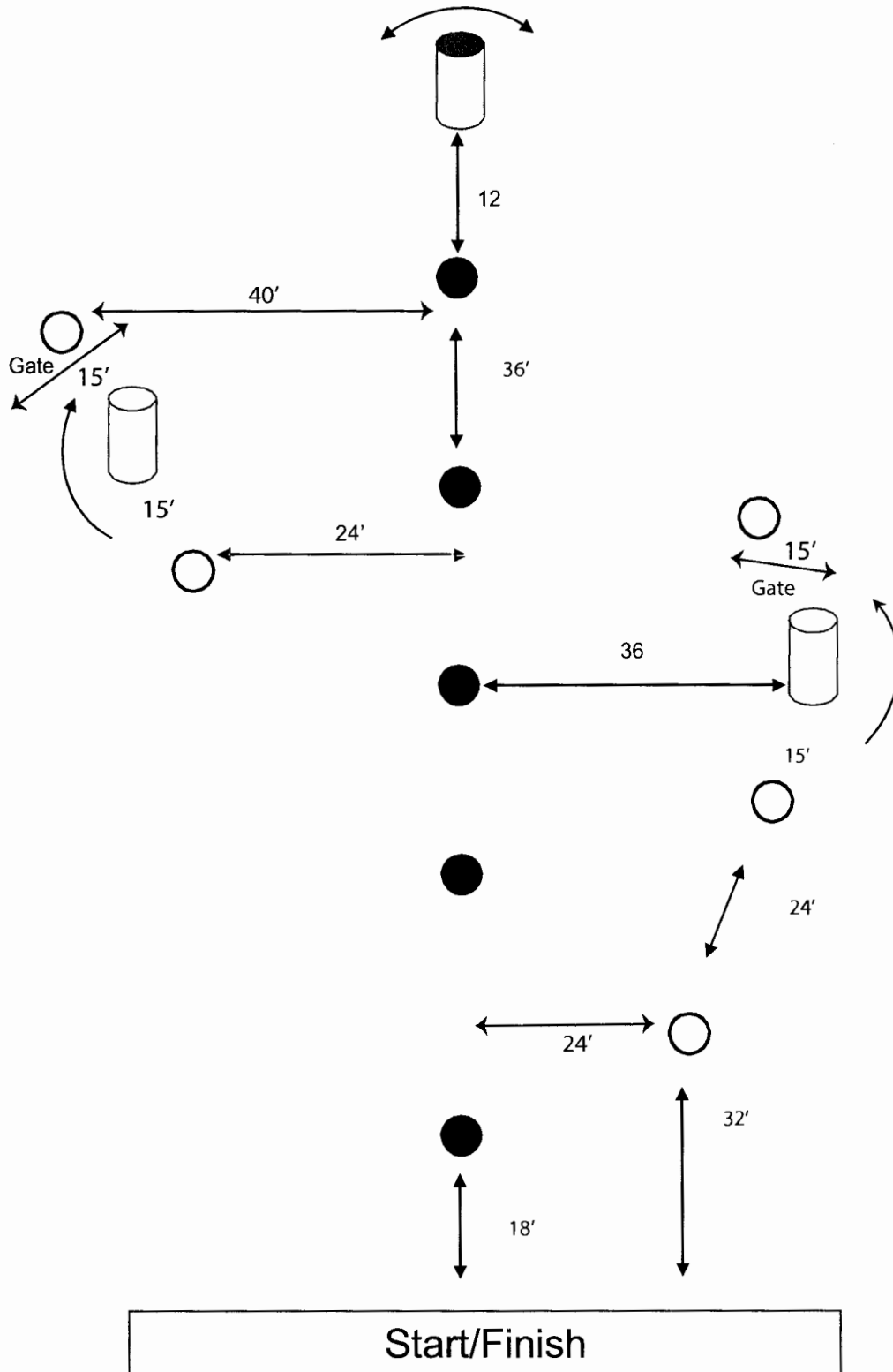

Course Rules

- 1) Shoot the entire random course
- 2) Round rundown barrel
- 3) Shoot all dark targets

Pattern 52
CERTIFIED COURSE

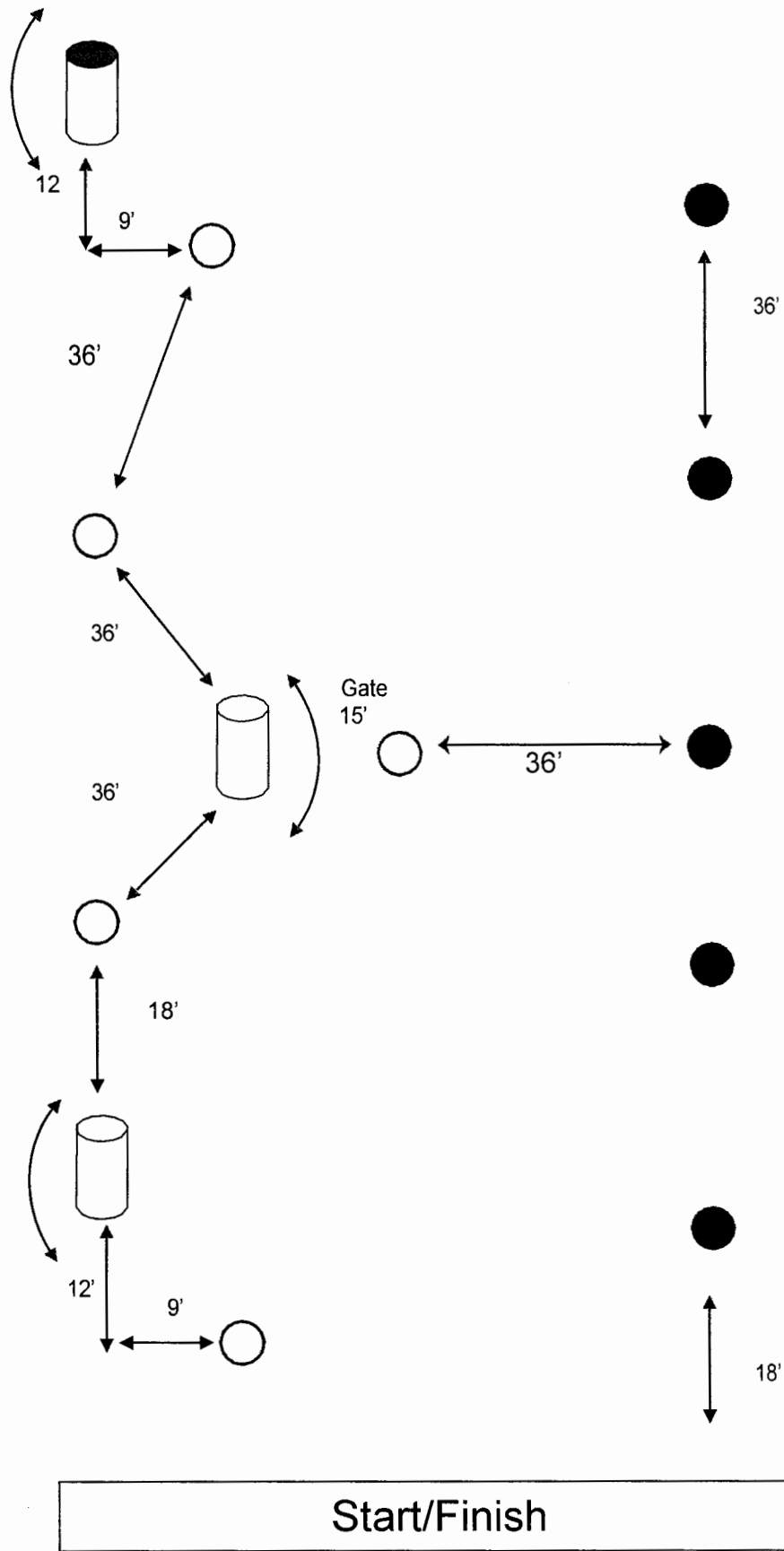

Course Rules

- 1) Shoot all of the light targets first
- 2) Proceed to go round rundown barrel
- 5) Shoot all dark targets

**Pattern 53
CERTIFIED
COURSE**

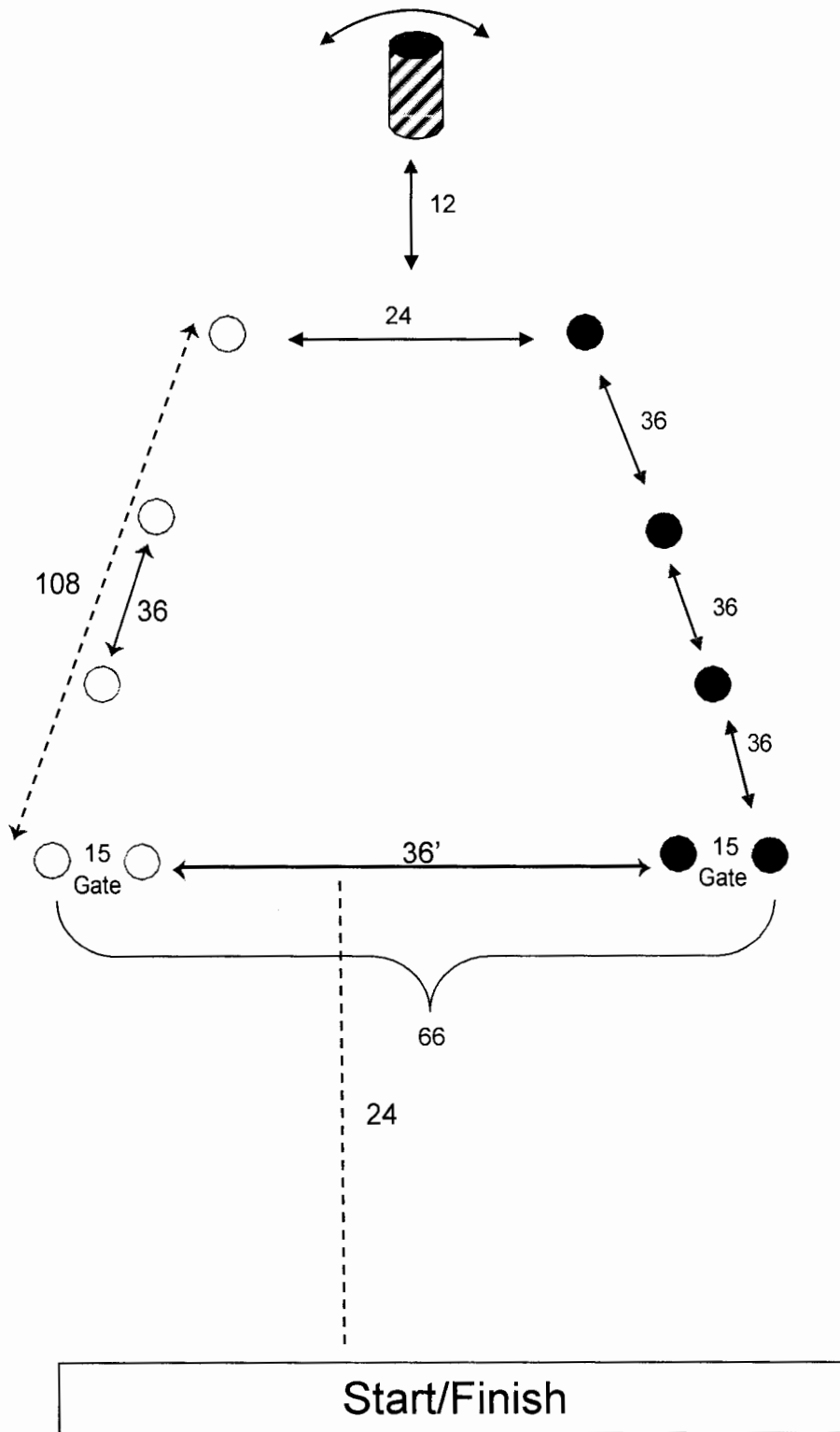

Course Rules

- 1) Shoot all targets of the same color
- 2) Round the rundown barrel
- 3) Shoot all targets of the remaining color

Pattern 54
CERTIFIED
COURSE

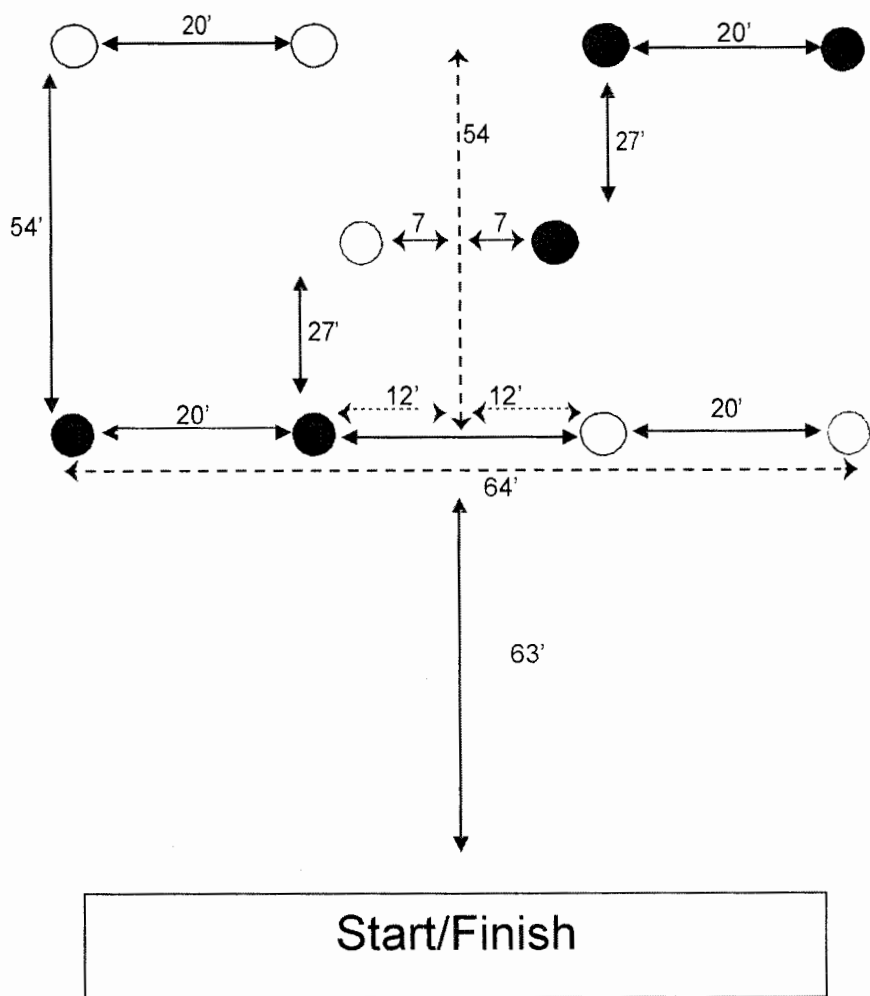

Course Rules

- 1) Shoot all targets of the same color
- 2) Shoot all targets of the remaining color.

Pattern 55
**CERTIFIED
 COURSE**

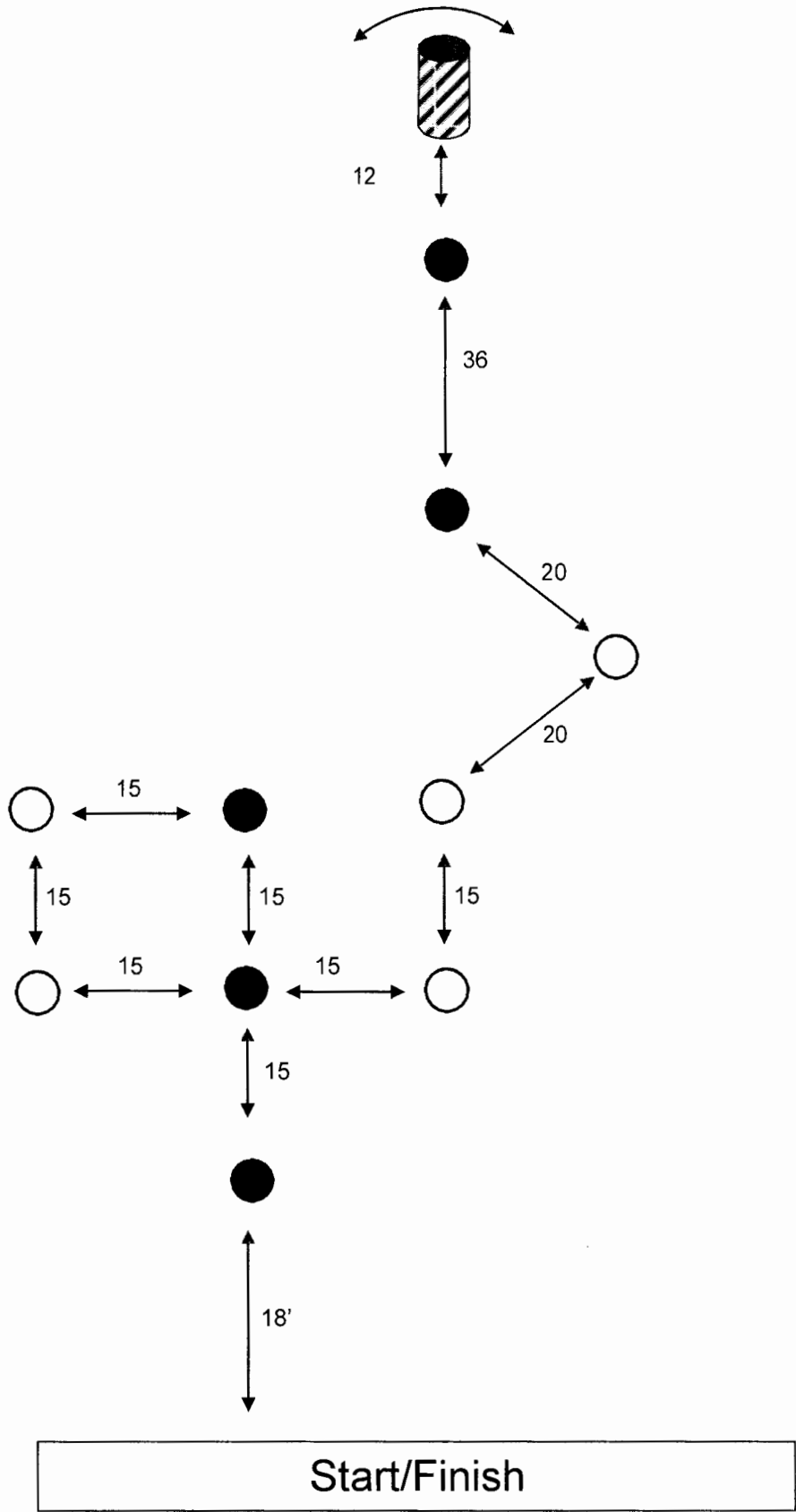

Course Rules

- 1) Shoot all targets of the same color
- 2) Round rundown barrel
- 3) Shoot all targets of the remaining color

Pattern 56
CERTIFIED COURSE

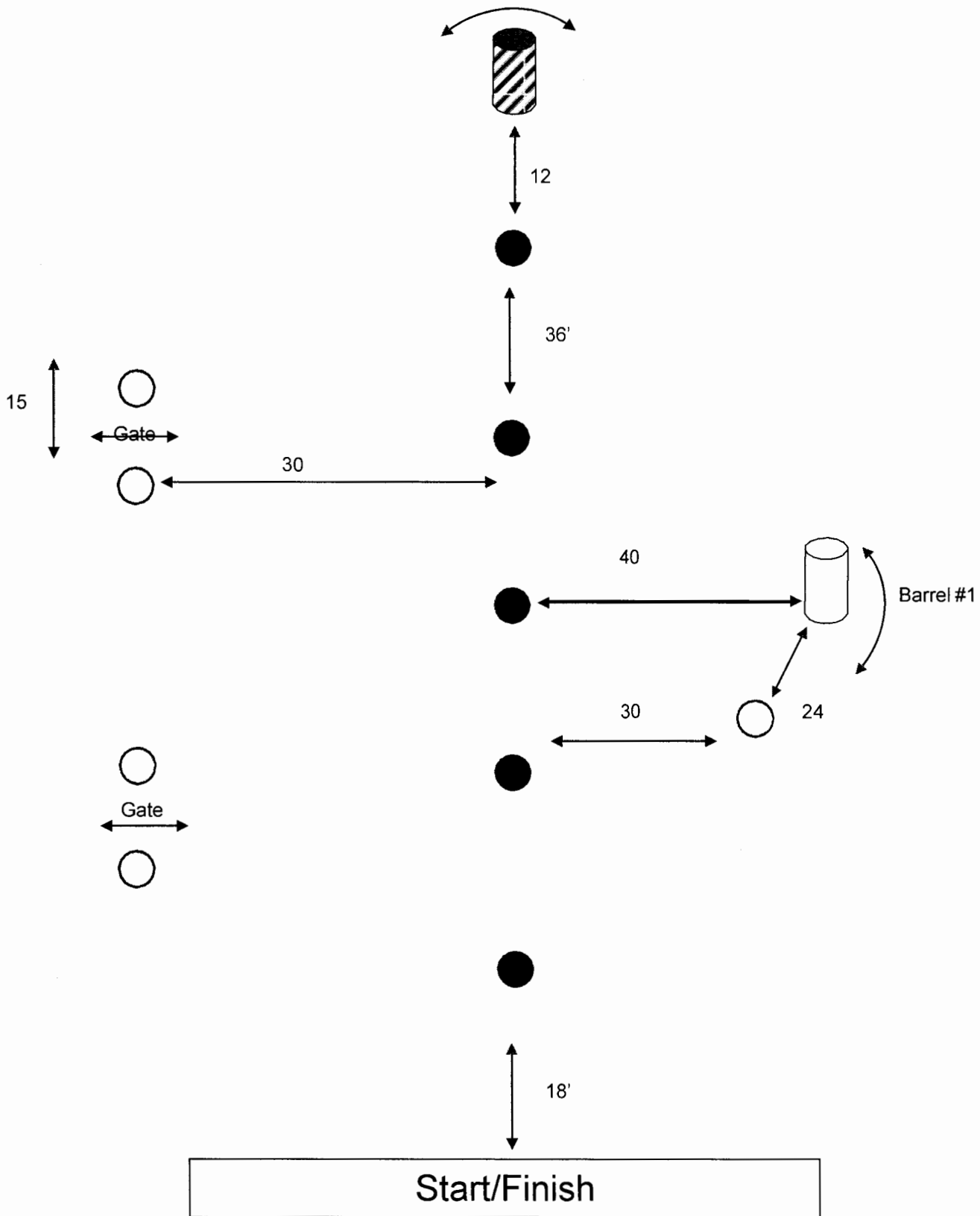

Course Rules

- 1) Shoot the entire random course
- 2) Proceed to go round rundown barrel
- 3) Shoot all dark targets

Pattern 57
CERTIFIED COURSE

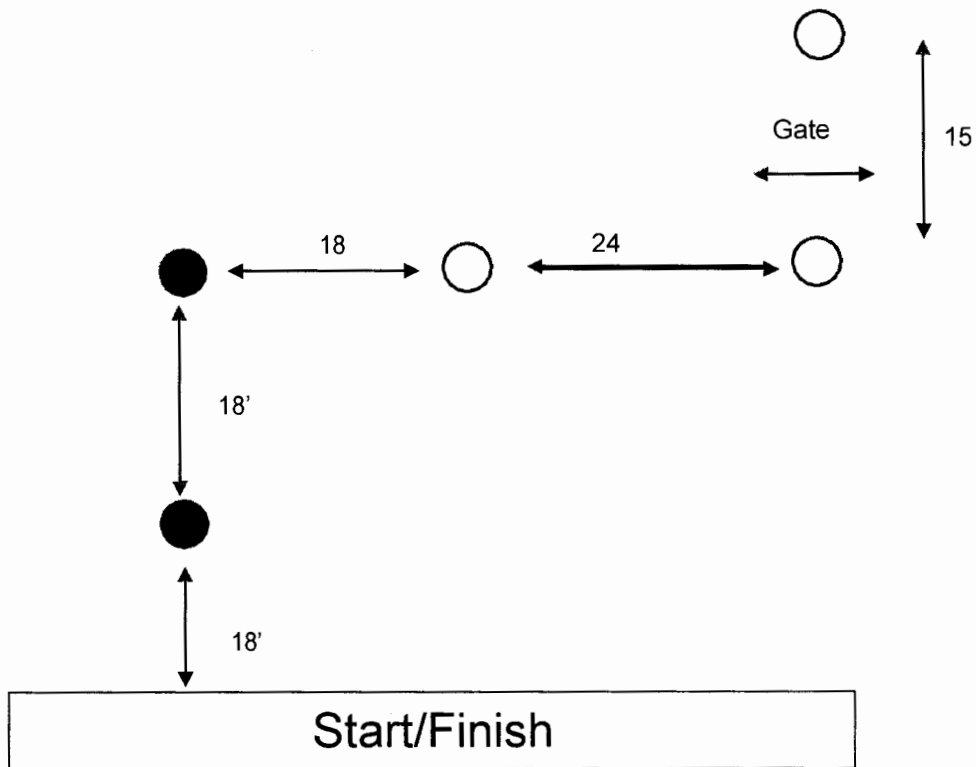
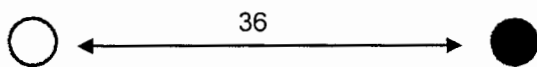
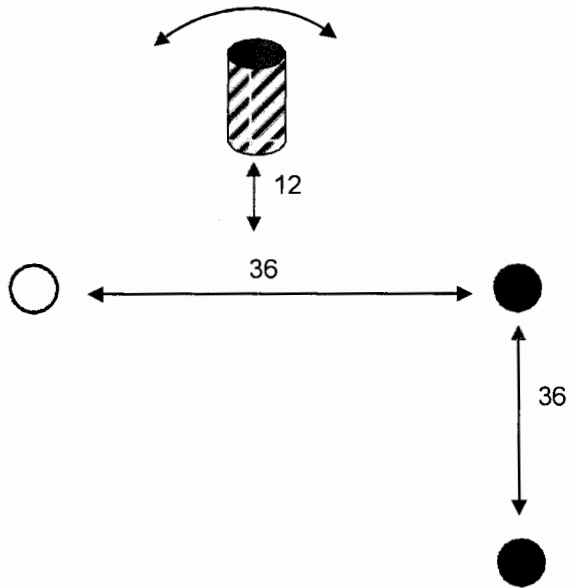

Course Rules

- 1) Shoot all targets of the same color
- 2) Round rundown barrel
- 3) Shoot all targets of the remaining color

Pattern 58
CERTIFIED COURSE

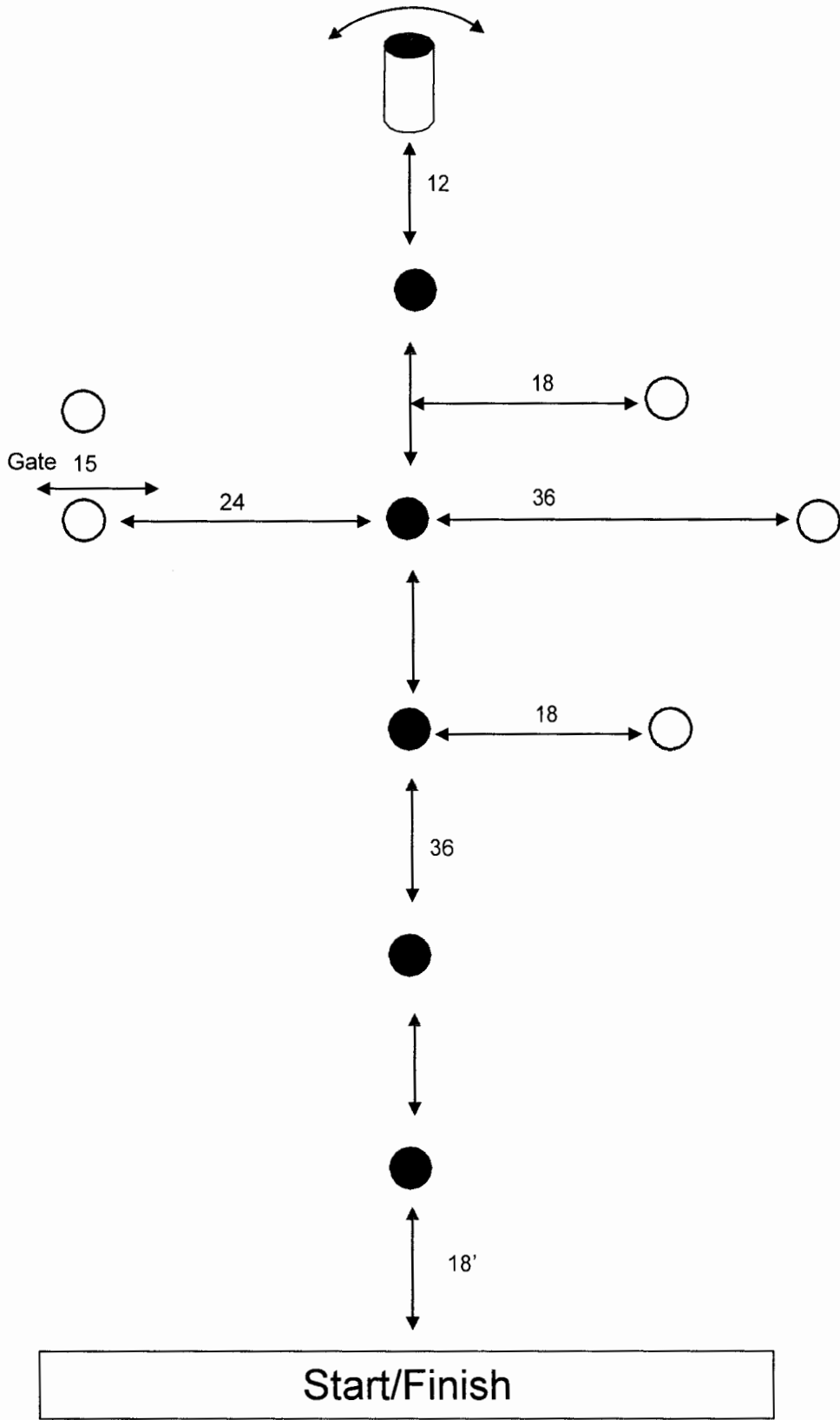

Course Rules

- 1) Shoot all light targets
- 2) Round rundown barrel
- 3) Shoot all dark targets

Pattern 59
CERTIFIED COURSE

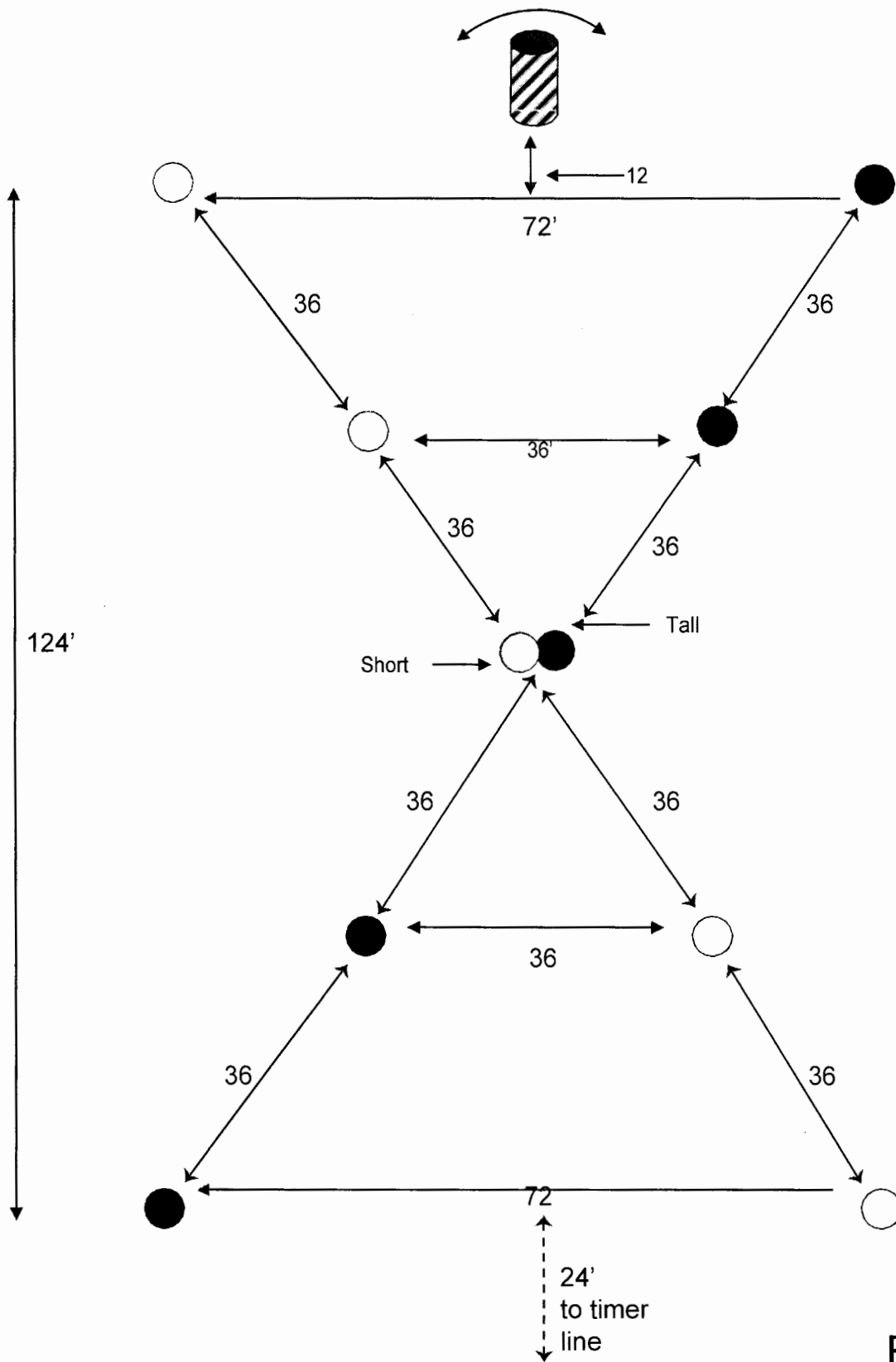

Course Rules

- 1) Shoot all targets of the same color
- 2) Round rundown barrel
- 3) Shoot all targets of the remaining color

**Pattern 60
CERTIFIED
COURSE**

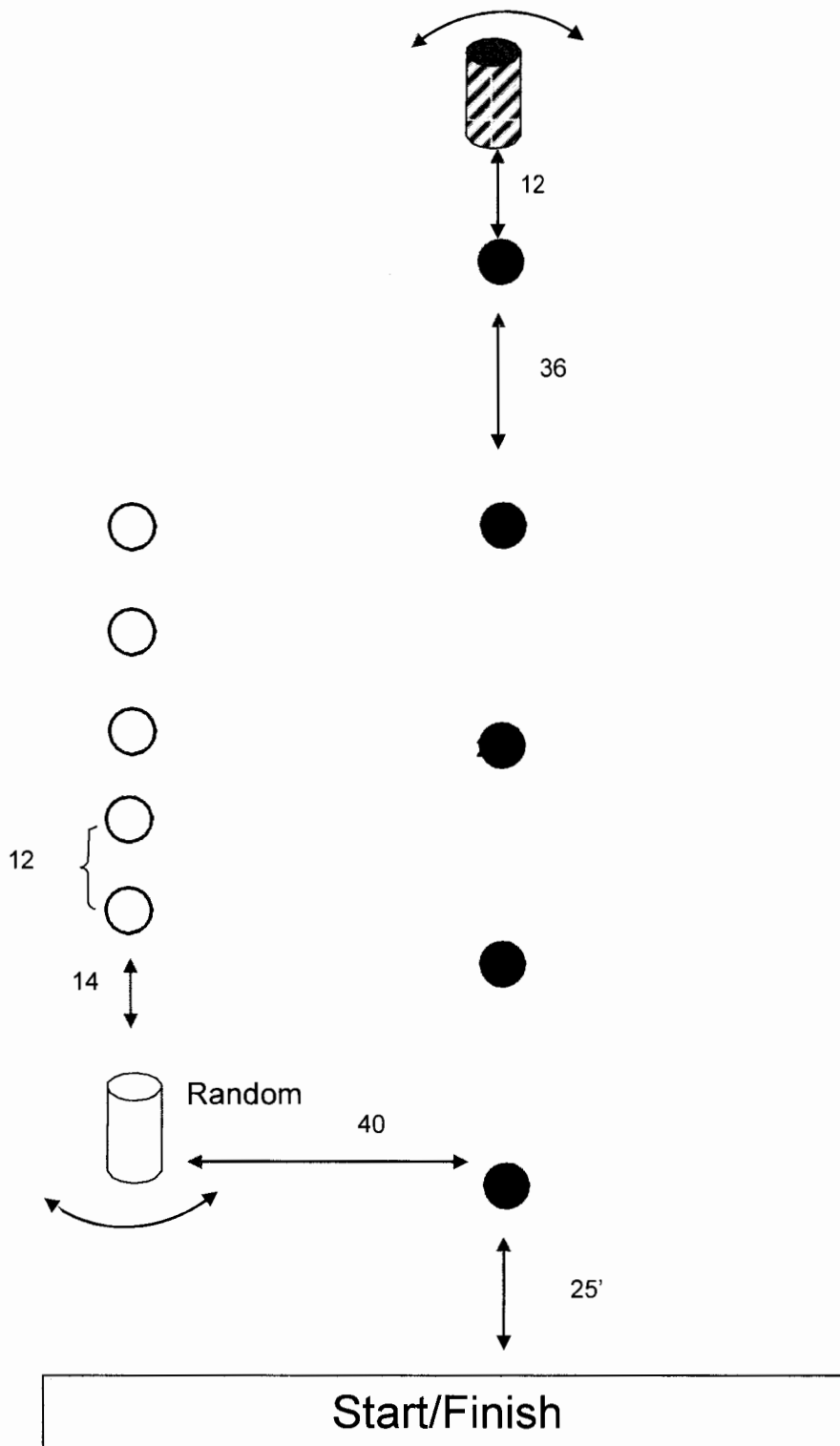

Course Rules

- 1) Shoot all light targets
- 2) Round random barrel
- 3) Proceed to and round rundown barrel
- 4) Shoot all dark targets

Pattern 61
CERTIFIED
COURSE